

Operating Instruction

HD Integrated Camera

Model No. **AW-HE130WP**

Model No. **AW-HE130KP**

Model No. **AW-HE130WE**

Model No. **AW-HE130KE**

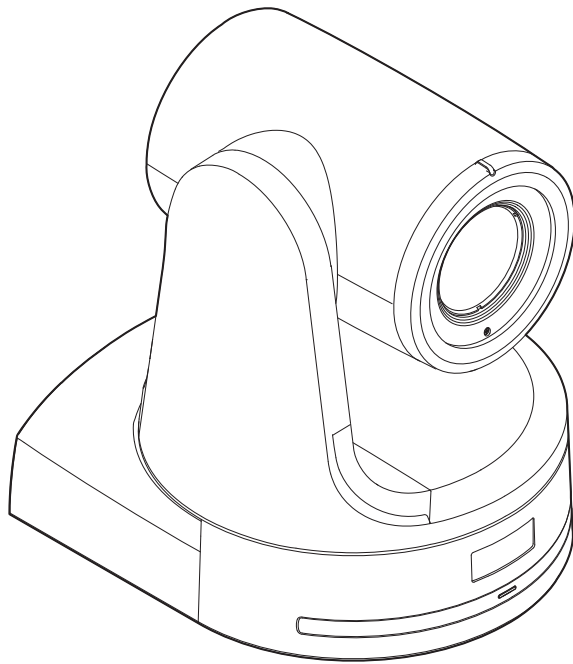

HDMI

Before operating this product, please read the instructions carefully and save this manual for future use.

● **About the instruction manuals**

• **Operating Instructions (this document):**



This manual describes how to operate and configure settings for the unit.

• **Installation Instructions:**

This manual includes information on installation and system configurations for the unit.

Be sure to read this before installing the unit to ensure proper installation.

Read this first! (For AW-HE130WP, AW-HE130KP)

	CAUTION RISK OF ELECTRIC SHOCK DO NOT OPEN	
CAUTION: TO REDUCE THE RISK OF ELECTRIC SHOCK, DO NOT REMOVE COVER (OR BACK). NO USER SERVICEABLE PARTS INSIDE. REFER TO SERVICING TO QUALIFIED SERVICE PERSONNEL.		

 The lightning flash with arrowhead symbol, within an equilateral triangle, is intended to alert the user to the presence of uninsulated "dangerous voltage" within the product's enclosure that may be of sufficient magnitude to constitute a risk of electric shock to persons.

 The exclamation point within an equilateral triangle is intended to alert the user to the presence of important operating and maintenance (servicing) instructions in the literature accompanying the appliance.

WARNING:

- To reduce the risk of fire or electric shock, do not expose this equipment to rain or moisture.
- To reduce the risk of fire or electric shock, keep this equipment away from all liquids. Use and store only in locations which are not exposed to the risk of dripping or splashing liquids, and do not place any liquid containers on top of the equipment.

WARNING:

Always keep the main unit mounting screw, bracket mounting screws and drop-prevention wire mounting screw out of the reach of infants and small children.

CAUTION:

This apparatus can be operated at a voltage in the range of 100 – 240 V AC. Voltages other than 120 V are not intended for U.S.A. and Canada. Operation at a voltage other than 120 V AC may require the use of a different AC plug. Please contact either a local or foreign Panasonic authorized service center for assistance in selecting an alternate AC plug.

CAUTION:

The mains plug of the power supply cord shall remain readily operable. The AC receptacle (mains socket outlet) shall be installed near the equipment and shall be easily accessible. To completely disconnect this equipment from the AC mains, disconnect the power cord plug from the AC receptacle.

CAUTION:

In order to maintain adequate ventilation, do not install or place this unit in a bookcase, built-in cabinet or any other confined space. To prevent risk of electric shock or fire hazard due to overheating, ensure that curtains and any other materials do not obstruct the ventilation.

CAUTION:

To reduce the risk of fire or electric shock and annoying interference, use the recommended accessories only.

CAUTION:

Check the installation at least once a year. An improper installation could cause the unit to fall off resulting in personal injury.

CAUTION:

Do not pick up and move the unit while the tripod is attached. The fitting may break under the weight of the tripod, which may result in injury.

 indicates safety information.

FCC NOTICE (USA)

This device complies with part 15 of the FCC Rules.

Operation is subject to the following two conditions:

(1) This device may not cause harmful interference, and (2) this device must accept any interference received, including interference that may cause undesired operation.

FCC Warning:

To assure continued FCC emission limit compliance, follow the attached installation instructions and the user must use only shielded interface cables when connecting to host computer or peripheral devices. Also, any unauthorized changes or modifications to this equipment could void the user's authority to operate this device.

FCC CAUTION:

This equipment has been tested and found to comply with the limits for a class A digital device, pursuant to Part 15 of the FCC Rules.

These limits are designed to provide reasonable protection against harmful interference when the equipment is operated in a commercial environment. This equipment generates, uses, and can radiate radio frequency energy and, if not installed and used in accordance with the instruction manual, may cause harmful interference to radio communications.

Operation of this equipment in a residential area is likely to cause harmful interference in which case the user will be required to correct the interference at his own expense.

NOTIFICATION (Canada)

CAN ICES-3 (A)/NMB-3(A)

 indicates safety information.

IMPORTANT SAFETY INSTRUCTIONS

- 1) Read these instructions.
- 2) Keep these instructions.
- 3) Heed all warnings.
- 4) Follow all instructions.
- 5) Do not use this apparatus near water.
- 6) Clean only with dry cloth.
- 7) Do not block any ventilation openings. Install in accordance with the manufacturer's instructions.
- 8) Do not install near any heat sources such as radiators, heat registers, stoves, or other apparatus (including amplifiers) that produce heat.
- 9) Do not defeat the safety purpose of the polarized or grounding-type plug. A polarized plug has two blades with one wider than the other. A grounding-type plug has two blades and a third grounding prong. The wide blade or the third prong are provided for your safety. If the provided plug does not fit into your outlet, consult an electrician for replacement of the obsolete outlet.
- 10) Protect the power cord from being walked on or pinched particularly at plugs, convenience receptacles, and the point where they exit from the apparatus.
- 11) Only use attachments/accessories specified by the manufacturer.
- 12) Use only with the cart, stand, tripod, bracket, or table specified by the manufacturer, or sold with the apparatus. When a cart is used, use caution when moving the cart/apparatus combination to avoid injury from tip-over.
- 13) Unplug this apparatus during lightning storms or when unused for long periods of time.
- 14) Refer all servicing to qualified service personnel. Servicing is required when the apparatus has been damaged in any way, such as power-supply cord or plug is damaged, liquid has been spilled or objects have fallen into the apparatus, the apparatus has been exposed to rain or moisture, does not operate normally, or has been dropped.



Read this first! (For AW-HE130WE, AW-HE130KE)

WARNING:

- To reduce the risk of fire or electric shock, do not expose this equipment to rain or moisture.
- To reduce the risk of fire or electric shock, keep this equipment away from all liquids. Use and store only in locations which are not exposed to the risk of dripping or splashing liquids, and do not place any liquid containers on top of the equipment.

WARNING:

Always keep the main unit mounting screw, bracket mounting screws and drop-prevention wire mounting screw out of the reach of infants and small children.

CAUTION:

Do not remove panel covers by unscrewing.
To reduce the risk of electric shock, do not remove the covers.
No user serviceable parts inside.
Refer servicing to qualified service personnel.

CAUTION:

The mains plug of the power supply cord shall remain readily operable.
The AC receptacle (mains socket outlet) shall be installed near the equipment and shall be easily accessible. To completely disconnect this equipment from the AC mains, disconnect the power cord plug from the AC receptacle.

CAUTION:

In order to maintain adequate ventilation, do not install or place this unit in a bookcase, built-in cabinet or any other confined space. To prevent risk of electric shock or fire hazard due to overheating, ensure that curtains and any other materials do not obstruct the ventilation.

CAUTION:

To reduce the risk of fire or electric shock and annoying interference, use the recommended accessories only.

CAUTION:

Check the installation at least once a year.
An improper installation could cause the unit to fall off resulting in personal injury.

CAUTION:

Do not pick up and move the unit while the tripod is attached.
The fitting may break under the weight of the tripod, which may result in injury.

 indicates safety information.

Turkey Only

AEEE Yönetmeliğine Uygundur.

AEEE Complies with Directive of Turkey.

Caution for AC Mains Lead

FOR YOUR SAFETY PLEASE READ THE FOLLOWING TEXT CAREFULLY.

This product is equipped with 2 types of AC mains cable. One is for continental Europe, etc. and the other one is only for U.K.

Appropriate mains cable must be used in each local area, since the other type of mains cable is not suitable.

FOR CONTINENTAL EUROPE, ETC.

Not to be used in the U.K.



FOR U.K. ONLY

If the plug supplied is not suitable for your socket outlet, it should be cut off and appropriate one fitted.

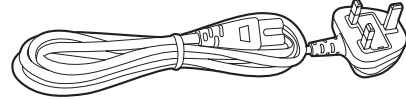



FOR U.K. ONLY

This appliance is supplied with a moulded three pin mains plug for your safety and convenience.

A 5 amp fuse is fitted in this plug.

Should the fuse need to be replaced please ensure that the replacement fuse has a rating of 5 amps and that it is approved by ASTA or BSI to BS1362.

Check for the ASTA mark  or the BSI mark  on the body of the fuse.

If the plug contains a removable fuse cover you must ensure that it is refitted when the fuse is replaced.

If you lose the fuse cover the plug must not be used until a replacement cover is obtained.

A replacement fuse cover can be purchased from your local Panasonic Dealer.

How to replace the fuse

1. Open the fuse compartment with a screwdriver.

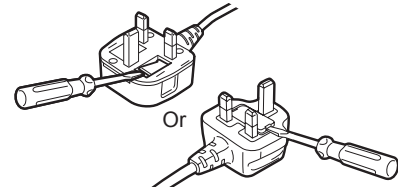

2. Replace the fuse.

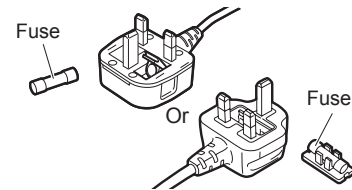

 indicates safety information.

EMC NOTICE FOR THE PURCHASER/USER OF THE APPARATUS

1. Pre-requisite conditions to achieving compliance with the above standards

<1> Peripheral equipment to be connected to the apparatus and special connecting cables

- The purchaser/user is urged to use only equipment which has been recommended by us as peripheral equipment to be connected to the apparatus.
- The purchaser/user is urged to use only the connecting cables described below.

<2> For the connecting cables, use shielded cables which suit the intended purpose of the apparatus.

- Video signal connecting cables
Use double shielded coaxial cables, which are designed for 75-ohm type high-frequency applications, for SDI (Serial Digital Interface). Coaxial cables, which are designed for 75-ohm type high-frequency applications, are recommended for analog video signals.
- Audio signal connecting cables
If your apparatus supports AES/EBU serial digital audio signals, use cables designed for AES/EBU.
Use shielded cables, which provide quality performance for high-frequency transmission applications, for analog audio signals.
- Other connecting cables (IEEE1394, USB)
Use double shielded cables, which provide quality performance for high-frequency applications, as connecting cables.
- When connecting to the DVI signal terminal, use a cable with a ferrite core.
- If your apparatus is supplied with ferrite core(s), they must be attached on cable(s) following instructions in this manual.

2. Performance level

The performance level of the apparatus is equivalent to or better than the performance level required by these standards. However, the apparatus may be adversely affected by interference if it is being used in an EMC environment, such as an area where strong electromagnetic fields are generated (by the presence of signal transmission towers, cellular phones, etc.). In order to minimize the adverse effects of the interference on the apparatus in cases like this, it is recommended that the following steps be taken with the apparatus being affected and with its operating environment:

1. Place the apparatus at a distance from the source of the interference.
2. Change the direction of the apparatus.
3. Change the connection method used for the apparatus.
4. Connect the apparatus to another power outlet where the power is not shared by any other appliances.

Manufactured by: Panasonic Corporation, Osaka, Japan
 Importer's name and address of pursuant to EU rules:
 Panasonic Marketing Europe GmbH
 Panasonic Testing Centre
 Winsbergring 15, 22525 Hamburg, Germany

ІНФОРМАЦІЯ ПРО ПІДТВЕРДЖЕННЯ ВІДПОВІДНОСТІ ПРОДУКТУ

Виробник:	Panasonic Corporation	Панасонік Корпорейшн
Адреса виробника:	Kadoma, Osaka, Japan	Кадома, Осака, Японія
Країна походження:	China	Китай

Уповноважений Представник:	ТОВ "ПАНАСОНІК УКРАЇНА ЛТД"
Адреса Уповноваженого Представника:	провулок Охтирський, будинок 7, місто Київ, 03022, Україна

Примітки:

Термін служби виробу	7 років
----------------------	---------

Дату виготовлення можна визначити за комбінацією букв і цифр серійного номера, що розташований на маркувальній табличці виробу.

Приклад: X X XXXXXXXX

Рік: остання цифра року (4 – 2014, 5 – 2015,...0 – 2020)
Місяць: А – Січень, В – Лютий... L – Грудень

■ The symbols on this product (including the accessories) represent the following. (Some symbols are not displayed on this unit.)

I	ON
	Standby (OFF)
~	AC
==	DC
	Class II equipment (The construction of the product is double-insulated.)

Read this first!

Note on grounding

- Ground the unit via the <SIGNAL GND> ground connector.

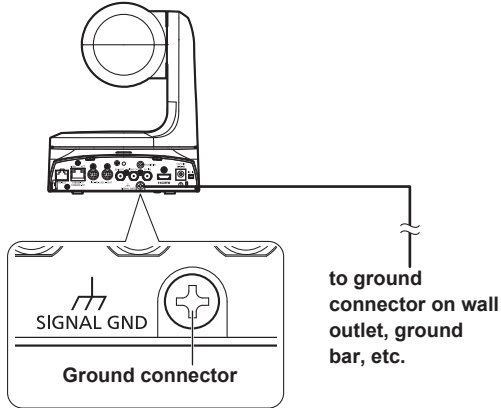

Trademarks and registered trademarks

- Microsoft®, Windows®, Windows® 7, Windows® 8, Windows® 8.1, Internet Explorer®, ActiveX® and DirectX® are either registered trademarks or trademarks of Microsoft Corporation in the United States and other countries.
- Apple, Mac, OS X, iPhone, iPod Touch, iPad, and Safari are registered trademarks of Apple Inc., in the United States and other countries.
- Android™ is a trademark of Google Inc.
- Intel® and Intel® Core™ are trademarks or registered trademarks of Intel Corporation in the United States and other countries.
- Adobe® and Reader® are either registered trademarks or trademarks of Adobe Systems Incorporated in the United States and/or other countries.
- The terms HDMI and HDMI High-Definition Multimedia Interface, and the HDMI Logo are trademarks or registered trademarks of HDMI Licensing Administrator, Inc. in the United States and other countries.
- Other names of companies and products contained in these Operating Instructions may be trademarks or registered trademarks of their respective owners.

About copyright and licence

Distributing, copying, disassembling, reverse compiling, reverse engineering, and also exporting in violation of export laws of the software provided with this unit are expressly prohibited.

Abbreviations

The following abbreviations are used in this manual.

- Microsoft® Windows® 7 Professional SP1 32/64-bit is abbreviated to “Windows 7”.
- Microsoft® Windows® 8 Pro 32/64-bit is abbreviated to “Windows 8”.
- Microsoft® Windows® 8.1 Pro 32/64-bit is abbreviated to “Windows 8.1”.
- Windows® Internet Explorer® 8.0, Windows® Internet Explorer® 9.0, Windows® Internet Explorer® 10.0 and Windows® Internet Explorer® 11.0 are abbreviated to “Internet Explorer”.

For the purposes of this manual, the model numbers of the units are given as listed in the table below.

Model number of unit	Model number given in manual
AW-HE130WP	AW-HE130
AW-HE130KP	
AW-HE130WE	
AW-HE130KE	
AW-HS50N	AW-HS50
AW-HS50E	
AW-RP50N	AW-RP50
AW-RP50E	
AW-RP120G	AW-RP120
AK-HRP200G	AK-HRP200

Illustrations and screen displays featured in the manual

- What is shown in the manual's illustrations and screen displays may differ from how it is actually appears.
- Functions which can be used by Windows only are indicated using the **Windows** mark.
- The screenshots are used in accordance with the guidelines of Microsoft Corporation.

Contents

Read this first! (For AW-HE130WP, AW-HE130KP)	2
Read this first! (For AW-HE130WE, AW-HE130KE)	4
Read this first!	7
Note on grounding	7
Before use	9
Overview	9
Computer requirements	9
Disclaimer of warranty	10
Network security	10
Features	11
Controller supported	12
Accessories	13
Optional accessories	13
Operating precautions	14
Wireless remote control (optional accessory)	16
Parts and their functions	17
Camera unit	17
Wireless remote control (not supplied)	20
Setting the remote control IDs	22
Network settings	23
Installing the software	23
Use the Easy IP Setup Software to establish the unit's settings	23
Installing the plug-in viewer software	24
About the Upgrades of the AW-HE130 Firmware	24
Enable the user authentication function	24
Basic shooting operations	25
How to turn the power on and off	25
Turning the power on	25
Turning the power off	25
Selecting the units	26
Selecting the shooting modes (scene files)	27
Types of shooting modes	27
How to select the shooting mode	27
Shooting	28
What to do when encountering problems in the basic shooting operations	29
More advanced operations	29
Manual shooting	30
Manually adjusting the focus	30
Manually adjusting the iris	30
Manually adjusting the shutter speed	30
Manually adjusting the gain	30
Preset memories	31
White balance adjustment	32
Automatic adjustment (AWB: AWB A or AWB B)	32
Auto tracking white adjustment (ATW)	33
3200K and 5600K presets	33
VAR	33
Black balance adjustment	34
Automatic adjustment	34
Black level (master pedestal) adjustment	35
Genlock adjustment	36
Horizontal phase adjustment	36
Basic setup operations	37
When performing the operations using the wireless remote control ..	38
Operations on the AW-RP50 Remote Camera Controller	39
Operations on the AW-RP120 Remote Camera Controller	41
Operations on the AK-HRP200 Remote Operation Panel	43
Camera menu items	46
Setting the camera menu items	46
Top menu (Top Menu) screen	46
Camera screen	47
Brightness 1/2 screen	47
Brightness 2/2 screen	48
Picture 1/3 screen	49
Picture 2/3 screen	49
Picture 3/3 screen	50
Matrix 1/5 screen	50
Matrix 2/5 screen	51
Matrix 3/5 screen	51
Matrix 4/5 screen	52
Matrix 5/5 screen	52
System screen	53
Genlock screen	53
Output screen	54
Others 1/4 screen	56
Others 2/4 screen	56
Others 3/4 screen	57
Others 4/4 screen	57
Maintenance screen	58
Firmware VER 1/2 screen	58
Firmware VER 2/2 screen	58
IP Network screen	59
Camera menu item table	60
Displaying the web screen	63
Displaying the web screen using a personal computer	63
Switching between the Live screen [Live] and Web setup screen [Setup]	64
Web screen operations	65
Live screen [Live] : Single display mode	65
Live screen [Live] : Multi display mode	69
Web screen configurations	70
Logging into the Web setup screen [Setup]	70
Web setup screen [Setup]	70
Basic screen [Basic]	71
Image screen [Image]	72
Multi screen setup screen [Multi-Screen setup]	86
User management screen [User mng.]	87
Network setup screen [Network]	89
Maintenance screen [Maintenance]	101
Displaying the web screen using a mobile terminal	104
System log displays	108
Limiters	109
Setting/releasing the limiters	110
Setting/releasing the limiters	110
Setting the limiters	110
Releasing the limiters	110
Resetting the limiters	110
Safe mode	111
Concerning the safe mode	111
Detection of equipment trouble	111
Troubleshooting	112
Specifications	121
Index	123

Before use

Overview

- This unit is a full HD camera with an integrated pan-tilt head that features the newly developed 1/2.86-type full HD 3MOS sensor and digital signal processor (DSP).
- In addition to its optical 20× zoom lens, the unit is equipped with 10× digital zoom to achieve vibrant high-quality images that have a horizontal resolution of 1000 lines. With its high sensitivity and built-in image-shake correction and night-mode functions, the unit can record in a wide range of environments.
- When a controller is connected, camera operations can be performed smoothly via IP control or serial control.
- The unit features a night mode that exposes subjects to infrared rays, making it possible to shoot even under low-light conditions.
- When the unit is connected to a personal computer via an IP network, it can be operated via a web browser.
- Equipped with a newly developed codec engine, the unit can output Full HD images at up to 60 fps via a network.
- The unit supports standard serial communication formats, allowing connection to commercially available controllers.
- Connection with a Panasonic camera controller is also possible via Panasonic's proprietary serial communication format.
- The unit is available in white (AW-HE130WP/AW-HE130WE) or black (AW-HE130KP/AW-HE130KE) to suit your intended application and environment.

Computer requirements

CPU	Intel® Core™ 2 DUO 2.4 GHz or more recommended
Memory	For Windows: 1 GB or more (2 GB or more for 64-bit editions of Microsoft® Windows® 8.1, Microsoft® Windows® 8, and Microsoft® Windows® 7) For Mac: 2 GB or more
Network function	10BASE-T or 100BASE-TX port × 1
Image display	Resolution: 1024 × 768 pixels or more Color generation: True Color 24-bit or more
Supported operating systems and web browsers	For Windows: Microsoft® Windows® 8.1 Pro 64-bit / 32-bit *1 Windows® Internet Explorer® 11.0*1 *3 Microsoft® Windows® 8 Pro 64-bit / 32-bit *1 Windows® Internet Explorer® 10.0*1 *3 Microsoft® Windows® 7 Professional SP1 64-bit / 32-bit *2 Windows® Internet Explorer® 11.0 / 10.0 / 9.0 / 8.0 *3
	For Mac: OS X 10.9 Safari 7.0.2 OS X 10.8 Safari 6.1.2 OS X 10.7 Safari 6.1.2
	For iPhone, iPad, iPod touch: iOS 7.1 Standard web browsers
	For Android: Android OS Standard web browsers

*1 Use the desktop version of Internet Explorer. (Internet Explorer for Windows UI is not supported.)

*2 Windows® XP compatibility mode is not supported.

*3 The 64-bit version of Internet Explorer® is not supported.

IMPORTANT

- Failure to provide the required personal computer environment may slow down the delineation of the images on the screen, make it impossible for the web browser to work and cause other kinds of problems.

<NOTE>

- Depending on the software version of the unit, an update may be necessary.
- Use the desktop version of Internet Explorer. (Internet Explorer for Windows UI is not supported.)
- For the latest information on compatible operating systems and web browsers, visit the support desk at the following website.

<https://pro-av.panasonic.net/>

Disclaimer of warranty

IN NO EVENT SHALL Panasonic Corporation BE LIABLE TO ANY PARTY OR ANY PERSON, EXCEPT FOR REPLACEMENT OR REASONABLE MAINTENANCE OF THE PRODUCT, FOR THE CASES, INCLUDING BUT NOT LIMITED TO BELOW:

- ① ANY DAMAGE AND LOSS, INCLUDING WITHOUT LIMITATION, DIRECT OR INDIRECT, SPECIAL, CONSEQUENTIAL OR EXEMPLARY, ARISING OUT OF OR RELATING TO THE PRODUCT;
- ② PERSONAL INJURY OR ANY DAMAGE CAUSED BY INAPPROPRIATE USE OR NEGLIGENT OPERATION OF THE USER;
- ③ UNAUTHORIZED DISASSEMBLE, REPAIR OR MODIFICATION OF THE PRODUCT BY THE USER;
- ④ INCONVENIENCE OR ANY LOSS ARISING WHEN IMAGES ARE NOT DISPLAYED, DUE TO ANY REASON OR CAUSE INCLUDING ANY FAILURE OR PROBLEM OF THE PRODUCT;
- ⑤ ANY PROBLEM, CONSEQUENTIAL INCONVENIENCE, OR LOSS OR DAMAGE, ARISING OUT OF THE SYSTEM COMBINED BY THE DEVICES OF THIRD PARTY;
- ⑥ ANY DEMANDS FOR COMPENSATION, CLAIMS, ETC. OCCASIONED BY THE INFRINGEMENT OF PRIVACY BY INDIVIDUALS OR ORGANIZATIONS WHOSE IMAGES WERE SHOT BY THE USER BECAUSE THESE IMAGES (INCLUDING THE RECORDINGS MADE) WERE MADE AVAILABLE BY THE USER BECAUSE IN THE PUBLIC DOMAIN FOR SOME REASON OR OTHER OR BECAUSE THE IMAGES ENDED UP BEING USED FOR PURPOSES OTHER THAN THE ONE DESCRIBED ABOVE;
- ⑦ LOSS OF REGISTERED DATA CAUSED BY ANY FAILURE.

Network security

As the unit intended to be used while connected to a network, the following security risks exist.

- ① Leakage or theft of information through the unit
- ② Unauthorized operation of the unit by persons with malicious intent
- ③ Interference with or stoppage of the unit by persons with malicious intent

It is your responsibility to take precautions, such as those described below, to protect yourself against the above network security risks.

- Use the unit in a network secured by a firewall, etc.
- If the unit is connected to a network that includes personal computers, make sure that the system is not infected by computer viruses or other malicious programs (using a regularly updated antivirus program, anti-spyware program, etc.).
- Protect your network against unauthorized access by restricting users to those who log in with an authorized user name and password.
- After accessing the unit as an administrator, be sure to close all web browsers.
- Change the administrator password periodically.
- Restrict access to the unit by authenticating the users, for example, to prevent setting information stored on the unit from leaking over the network.
- Do not install the unit in locations where the unit, cables, and other parts can be easily damaged or destroyed by persons with malicious intent.
- Avoid connections that use public lines.

<NOTE>

Notes on user authentication

- User authentication on the unit can be performed via digest authentication or basic authentication. If basic authentication is used without the use of a dedicated authentication device, password leaks may occur. We recommend using digest authentication or host authentication.

Usage restrictions

- We recommend connecting the unit, controller, and any computers to the same network segment. Events based on settings inherent to the network devices, for example, may occur in connections that include different segments, so be sure to perform checks prior to operation.

Features

Multi-format support

- You can switch between the following formats via the camera menus or a web browser.

Supported formats:

1080/59.94p, 1080/29.97p*1, 1080/23.98p*2, 1080/59.94i, 1080/29.97PsF*2, 1080/23.98PsF, 720/59.94p, 480/59.94p (HDMI) or 480/59.94i (SDI), 1080/50p, 1080/25p*1, 1080/50i, 1080/25PsF*3, 720/50p, 576/50p (HDMI), and 576/50i (SDI)

*1 Native output

*2 OVER 59.94i output (your monitor may recognize the signal as 59.94i).

*3 OVER 50i output (your monitor may recognize the signal as 50i).

In terms of the VIDEO OUT signals, 480/59.94i or 576/50i signals are output regardless of the format settings.

These signals can be used for monitoring purposes.

There is however a delay in the VIDEO OUT signal output by 120H (HD lines) when at 720p and by 90H (HD lines) for any other.

- With the SD format, either "Squeeze", "LetterBox" or "SideCut" can be selected.

1/2.86-type MOS sensor and high-performance 20x zoom lens featured

- A newly developed 1/2.86-type full HD 3MOS sensor and DSP (digital signal processor) are incorporated. High-quality pictures are obtained by video processing in many different kinds of ways.
- In addition to its optical 20x zoom lens, the unit comes with a 10x digital zoom to achieve high-quality images that overflow with ambience.
- A dynamic range stretcher (DRS) function that compensates for overexposure and loss of dark detail and a digital noise reduction (DNR) function for minimizing image lag even in dark locations and shooting scenes clearly are incorporated to reproduce clean and clear images in a wide range of applications.

Easy operation of unit enabled by its integration with a high-performance pan-tilt head unit

- Operations at the high speed of 60°/s
- Wide rotational angles with a panning range of $\pm 175^\circ$ and a tilting range from -30° to 210°
- Quiet operation with noise levels of NC35
- Storage of up to 100 positions in the preset memory (The number of preset memories that can be used varies from one controller to another.)

Built-in night mode

- The unit supports infrared shooting. By exposing subjects to infrared rays, shooting under ordinarily difficult low-light conditions is possible. (Image output will be in black and white.)
- The iris will be fixed at open.

IP image output functions

- The unit is equipped with image compression and IP transmission LSI capabilities. Output in Full HD quality at up to 60 fps.
- Operation with IP control allows for a wide range of applications, such as controlling the camera from remote locations.

Standard serial communication support

- Connect up to seven cameras to a commercially available controller via RS-232C interface.

High degree of compatibility with Panasonic's currently available controllers, enabling a flexible system to be put together

- A maximum of five units can be operated by serial control from one of Panasonic's currently available controllers (AW-RP120, AW-RP50 and AW-HRP200). The unit can also be used together with the cameras and pan-tilt head unit systems currently available from Panasonic Corporation so that an existing system can be used to advantage to put together a system that is even more flexible.

<NOTE>

- It may be necessary to upgrade the version of the controller in order to support the unit. For details on upgrading, visit the support page on the following website.
<https://pro-av.panasonic.net/>
The maximum distances between the units and controller is 1000 meters (3280 ft). (when serial control is exercised)
Use of an external device or some other means must be provided separately in order to extend the video signal connections.

Easy construction of systems thanks to integrated design used for pan-tilt head, camera and lens

- By integrating the camera, lens and pan-tilt head into a single unit, it is now easier to construct systems.

Use of easy-to-operate wireless remote control (optional accessory) is possible

- A wireless remote control capable of operating up to four units can be used. It can easily be used to set the various functions or switch between them while viewing the menu screens.

Flexible camera layout enabled by simple connection and installation

- This unit features excellent connectivity and installability thanks to the IP control; a lightweight main unit, and the turn-lock mechanism, which enables the user to install it on his or her own (only when used indoors).

<NOTE>

- Bear in mind that this unit is designed to be used indoors only: It cannot be used outdoors.

Increased functionality with the same compact size and weight of previous models

- A wide range of features have been added while maintaining the compact size, weight, and footprint of previous models of the unit.

Easy connections and settings courtesy of IP control

- Up to a hundred units can be operated by IP connection from a Panasonic controller (AW-RP120, AW-RP50, AK-HRP200). (The maximum length of the LAN cables is 100 meters (328 ft).)

PoE+ *4 eliminates need for camera power configurations

- Configurations for camera's power supply are not necessary when the unit is connected to a network device that supports the PoE+ standard (IEEE802.3at compliant)*5.

<NOTE>

- When using a PoE+ device that requires software authentication, it may take a few minutes after power supply starts before the unit is operational.
- If the AC adaptor and a PoE+ power supply are connected simultaneously, the AC adaptor will have priority. If the AC adaptor is disconnected while both power supplies are connected, the unit will restart automatically, and the image will be interrupted.
- Use a Category 5e cable or higher when using a PoE+ power supply. The maximum length of the cable between the power supply unit and the unit is 100 meters (328 ft). Using a cable that is lower than Category 5 may result in reduced power supply capabilities.
- When a PoE+ injector is connected to a personal computer that supports Gigabit Ethernet using a straight LAN cable, the personal computer may not recognize the injector in rare cases. In such cases, connect the personal computer to the unit using a cross LAN cable (or via cross connection).

*4 Power over Ethernet Plus. Referred to as "PoE+" in this manual.

*5 For details on PoE+ devices for which operation has been verified, consult your local dealer or Panasonic representative.

Controller supported

- AW-RP120
- AW-RP50
- AK-HRP200

- It may be necessary to upgrade the version of the controller in order to support the unit.
For details on upgrading, visit the support page on the following website.
<https://pro-av.panasonic.net/>

<NOTE>

- The following operations can not be performed via the following controllers.

Item	AW-RP555	AW-RP655
Camera OSD menu operation	Supported	Supported
Scene	Supported *1 (1/2/3/USER)	Supported (HALOGEN/FLUORESCENT/OUTDOOR/USER)
Iris Mode	Supported	Supported
Shutter Mode	Supported with some restrictions *2 (Step only)	Not supported
Gain	Supported *1	Supported with some restrictions *3
ND Filter	Not supported	Not supported
Day/Night	Supported with some restrictions *4	Supported with some restrictions *4
White Balance Mode	Supported *1 (AWB A/AWB B/ATW only)	Supported (AWB A/AWB B/ATW only)
AWB/ABB	Supported	Supported
Color Temperature	Not supported	Not supported
R Gain / B Gain	Not supported	Supported
Pedestal	Not supported	Supported
R Pedestal / B Pedestal	Not supported	Supported with some restrictions *5
Detail	Not supported	Not supported
V Detail Level	Not supported	Not supported
CAM/BAR	Supported *1	Supported
Pan	Supported	Supported
Tilt	Supported	Supported
Preset	Supported	Supported
Preset Speed	Not supported	Not supported
Preset Speed Table	Not supported	Not supported
Preset Scope	Not supported	Not supported
Freeze During Preset	Not supported	Not supported
Focus Mode	Supported with some restrictions *4	Supported with some restrictions *4
Zoom	Supported	Supported
Digital Extender	Not supported	Not supported
OIS	Not supported	Not supported
Tally	Supported	Supported

*1 If the setting value is changed on another device, it may take some time for the setting value to be applied.

*2 If the Shutter Mode is not turned off/on after configuration, the value will not be changed.

*3 Improper operation will occur when Gain is set to 19 dB or higher.





*4 If the setting value is changed on another device, the setting value will not be applied.
(If the value is configured locally on the device, the value will be applied.)

*5 The value range display will be incorrect (-150 to +150).

Accessories

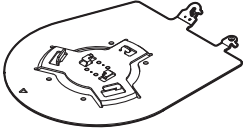
Check that the following accessories are present and accounted for.

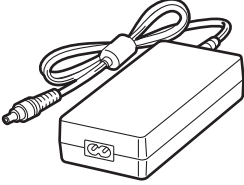
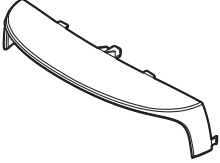
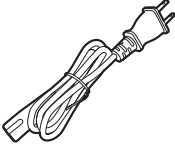
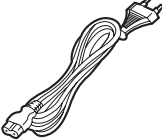
- After removing the product from its container, dispose of the power cable cap and packing materials in an appropriate manner.

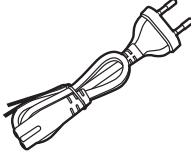
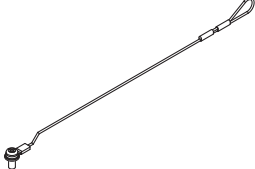
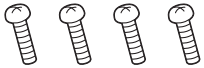
<p>Mount bracket for installation surface (Hanging / Desktop). (1)</p> 	<p>Main unit mounting screw (with flat washer, spring washer) M3×6 mm (1)</p> 	<p>AC adaptor (1)</p> 	<p>Cable cover (1)</p> 
<p>Power cable</p> <p>● AW-HE130WP/AW-HE130KP (1)</p>  <p>● AW-HE130WE/AW-HE130KE (2 types) (For areas other than the U.K.) (For the U.K.)</p>   <p>(1 type) This Indian model of the product includes only the AC cable designed for use in India.</p> 		<p>Drop-prevention wire. (1) Drop-prevention wire mounting screw(1) (comes attached to the unit)</p> 	
		<p>Bracket mounting screws (bind-head) M4×10 mm (4)</p> 	

Optional accessories

- Wireless remote controller AW-RM50G (Size “AA” dry battery x 2, obtained separately)
- Direct ceiling mount bracket WV-Q105

Operating precautions

■ Shoot under the proper lighting conditions.

To produce pictures with eye-pleasing colors, shoot under the proper lighting conditions.

The pictures may not appear with their proper colors when shooting under fluorescent lights. Select the proper lighting as required.

■ To ensure a stable performance in the long term

Using the unit for prolonged periods in locations where the temperature and humidity levels are high will cause its parts to deteriorate, resulting in a reduction of its service life.

(Recommended temperature: Max. 35 °C (95 °F))

Ensure that a cooling unit or heating unit will not blow any air directly toward the installation location.

■ Do not point the camera at strong lights.

When parts of the MOS sensor are exposed to spotlights or other strong lights, blooming (a phenomenon where the edges of strong lights become blurred) may occur.

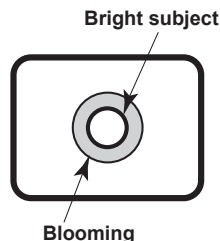

■ What happens with high-brightness subjects

Flare may occur if an extremely bright light source is pointed at the lens. In a case like this, change the angle or take some other remedial action.

■ When using the automatic functions

- The initial settings have been set to auto for some of the items of the scenes on the camera menus and other menus, making it impossible for these items to be operated manually. To operate them manually, switch from the auto settings to the manual settings as required.
- When using the ATW (auto tracking white adjustment) function under fluorescent lights, the white balance may vary.
- In some situations, it may be hard to focus at the auto setting. In cases like this, select the manual setting, and focus manually.

■ Zooming and focusing

When the focus is set manually, out-of-focusing may occur during zooming.

After zooming, if necessary, either adjust the focus or set the focus to auto.

When using the focus at the manual setting, proceed with zooming after setting the focus position at the Tele end where the focusing accuracy is higher. (However, if the distance from the unit to the subject is less than 1.5 meters (4.92 ft), the subject may shift out of focus at the Wide end.)

If zooming is performed to the Tele end after having adjusted the focus at the Wide end, out-of-focusing may occur.

■ Operation of the lens when the power is turned on

When the unit's power is turned on, the zoom, focus and iris are adjusted automatically.

■ The unit comes with the safe mode.

The safe mode is function designed to protect the unit from damage. For further details, refer to "Concerning the safe mode" (→ page 111).

■ Operating temperature range

Avoid using the unit in cold locations where the temperature drops below 0 °C (32 °F) or hot locations where the temperature rises above 40 °C (104 °F) since these temperatures downgrade the picture quality and adversely affect the internal parts.

■ Concerning the VIDEO OUT signal

The VIDEO OUT signal is provided in case the images are to be monitored.

■ Concerning the HDMI interface standard

This unit has been certified as HDMI-compatible, but on rare occasions images may not be displayed depending on the HDMI device which has been connected to the unit.

■ Color bars

- Color bars are used to adjust the color phase, and the widths and positions of these bars may differ from other models.
- The setting for the Down CONV. Mode item when color bars are displayed is fixed at "Squeeze".

■ Concerning the IP video frame rates

The IP video frame rate may be slower depending on the network environment, performance of your personal computer or mobile terminal, subject of the video, and access volume.

■ H.264 patent pool licensing

This product is licensed based on the AVC Patent Portfolio License, and the license does not extend beyond uses by users, who engage in the acts described below, for their own personal and non-profit applications.

- (i) Recording of image information in compliance with the AVC standard (hereafter, "AVC videos")
- (ii) Playing of AVC videos recorded by consumers engaging in personal activities or AVC videos acquired from licensed providers

For details, visit MPEG LA, LLC website (<http://www.mpegla.com>).

■ Concerning PoE+ power supply

The unit complies with the IEEE802.3at standard. Use a compatible Ethernet hub and PoE+ injector to use a PoE+ power supply.

For details on Ethernet hubs and PoE+ injectors for which operations have been verified, consult your local dealer.

■ Turn off the power before connecting or disconnecting the cables.

This unit is not equipped with a power switch.

Turn off the DC 12 V power supply or PoE+ power supply device before connecting or disconnecting cables.

■ Handle the unit carefully.

Do not drop the unit or subject it to strong impact or vibration. Failure to obey may cause the unit to malfunction.

■ When the unit is not in use

Turn off the unit's power when it is not in use.

When the unit is no longer going to be used, do not leave it lying around, but be absolutely sure to dispose of it properly.

■ Do not touch the optical system parts.

The optical system parts are vital to the operation of the camera. Under no circumstances must they be touched.

In the unlikely event that they have become dusty, remove the dust by using a camera blower or by wiping them gently with a lens cleaning paper.

■ Do not point the camera directly at the sun or a laser beam no matter whether it is turned on or not.

Taking images of the sun, laser beams, or other brightly lit subjects for prolonged periods of time may damage the CCD.

■ Personal computer used

If the same image is displayed for a prolonged period on a Personal computer's monitor, the monitor may be damaged. Use of a screen saver is recommended.

■ Concerning the IP address setting

Do not run the Easy IP Setup Software on a multiple number of personal computers for a single camera and set the IP address at the same time.

Otherwise, you will be unable to complete the proper procedure and set the IP address correctly.

■ **Do not allow foreign matter to make contact with the rotating parts.**

Failure to obey may cause the unit to malfunction.

■ **Do not get close to the moving parts of the camera head.**

Do not put your fingers or body close to the unit while it is in operation. Doing so may result in injury or cause the unit to malfunction.

Furthermore, if the unit hits a person or obstacle, during the panning or tilting operation, the unit will enter into the safe mode.

For further details, refer to page 111.

■ **Keep the unit away from water.**

Avoid all direct contact with water. Failure to obey may cause the unit to malfunction.

■ **Maintenance**

Turn off the unit's power before proceeding with maintenance.

Failure to obey may result in injuries.

Wipe the surfaces using a soft dry cloth. Avoid all contact with benzine, paint thinners and other volatile substances, and avoid using these substances. Otherwise, the casing may become discolored.

■ **Do not turn the camera head by hand.**

Turning the camera head by hand may cause the unit to malfunction.

■ **Use the unit in an environment with minimal moisture and dust.**

Avoid using the unit in an environment with high concentration of moisture or dust since these conditions will damage the internal parts.

■ **Disposal of the unit**

When the unit has reached the end of its service life and is to be disposed of, ask a qualified contractor to dispose of the unit properly in order to protect the environment.

■ **Information on software used with this product**

This product includes GNU General Public License (GPL) and GNU Lesser General Public License (LGPL) licensed software, and the customer is entitled to obtain, modify, or redistribute the source code for the software.

This product includes MIT Licensed software.

This product includes BSD Licensed software.

For details on obtaining the source codes, visit the following website.

<https://pro-av.panasonic.net/>

However, do not contact Panasonic for questions regarding obtained source codes.

Wireless remote control (optional accessory)

This unit can be operated by remote control using a wireless remote control (model number: AW-RM50G) purchased separately. Check out the following points before using the wireless remote control.

- Point the wireless remote control at the unit's wireless remote control signal light-sensing area (front panel or back panel), and operate it within a range of 10 meters (32.8 ft) from these areas.
- Refer to "Layout of wireless remote control signal light-sensing areas" on the right.
- The signal sensing distance is reduced if the angle at which the wireless remote control signals are sensed is increased.
The light-sensing sensitivity is reduced to about one-half when the wireless remote control is pointed at an angle of 40 degrees from each position in front of a wireless remote control signal light-sensing area (front panel or back panel).
If the remote control is operated from the behind the unit, it may be either difficult or impossible to perform the desired operations.
- If the unit is installed near fluorescent lights, plasma monitors or other such products or if the unit is exposed to sunlight, the effects of the light may make it impossible for the unit to be operated using the wireless remote control.

Be sure to follow the steps below for installation and use.

- Take steps to ensure that the wireless remote control signal light-sensing area will not be exposed to the light from fluorescent lights, plasma monitors or other such products or from the sun.
- Install the unit away from fluorescent lights, plasma monitors and other such products.
- For about 10 minutes even after the batteries have been removed from the wireless remote control, the selection of the operation to be performed (the <CAM1>, <CAM2>, <CAM3> or <CAM4> button which was pressed last) will remain stored in the memory. When a longer period of time elapses, however, the selection is reset to the status established when the <CAM1> button was pressed.

<Layout of wireless remote control signal light-sensing areas>

<NOTE>

- The arrows in the figure below show the light-sensing directions in which the wireless remote control signals travel.

Wireless remote control signal light-sensing area (back panel, 1 place)

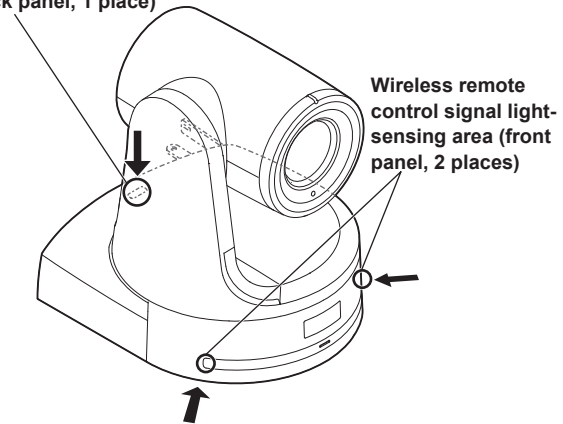

• Top view

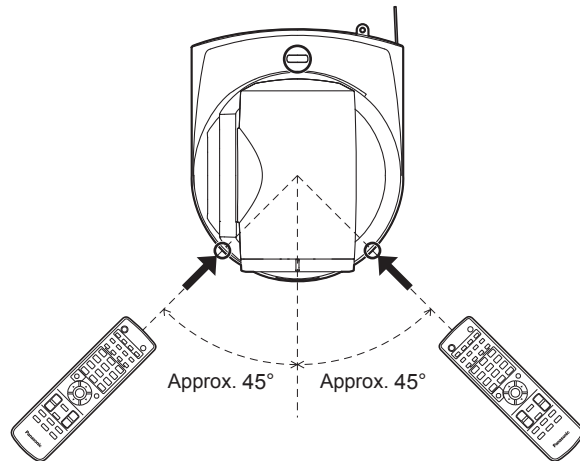

• Rear panel view

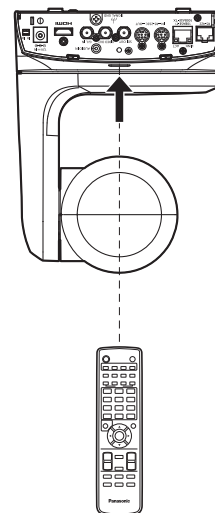

Parts and their functions

Camera unit

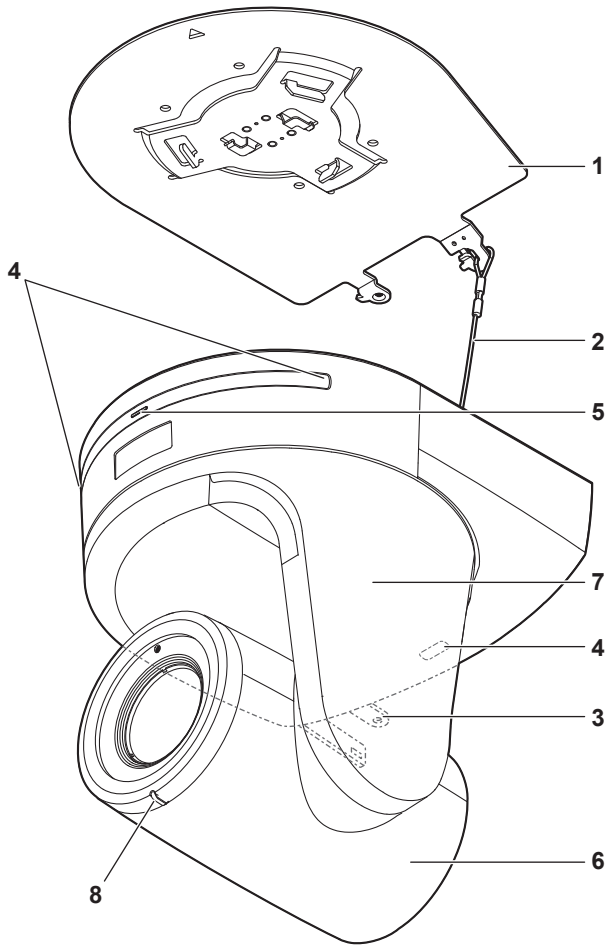

1. Mount bracket for installation surface (supplied accessory)

Mount this bracket onto the installation surface, and then attach the camera main unit to the bracket.

2. Drop-prevention wire

This wire is screwed down to the bottom panel of the camera main unit. Loop the circle part of the wire around the hook of the mount bracket.

3. Hole for securing the camera pedestal

This hole is provided in the bottom panel of the camera pedestal.

4. Wireless remote control signal light-sensing area

The light-sensing area is provided in three places, on the front panel of the camera pedestal and at the top of the rear panel.

5. Status display lamp

This lights in the following way depending on the status of the unit.

Orange: When the standby status is established

Green: When the power is on

Red: When trouble has occurred in the unit

Green and blinks twice:

When a signal matched by the remote control ID has been received from the wireless remote control (optional accessory) while the power is on

Orange and blinks twice:

When a signal not matched by the remote control ID has been received from the wireless remote control (optional accessory) while the power is on

6. Camera head

This rotates in the up and down direction.

7. Tilt head

This rotates in the right and left direction.

8. Tally lamp

This comes on or goes off in response to the control from the controller but only when "On" has been selected as the tally lamp use setting.

Rear panel

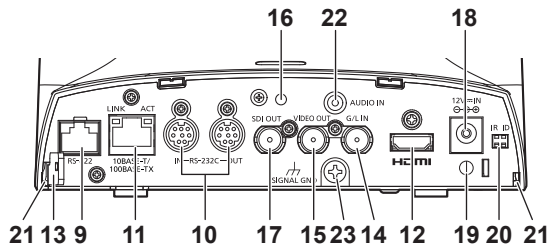

9. RS-422 connector <RS-422>

This RS-422 connector (RJ45) is connected when exercising serial control over the unit from an external device. Use a cable with the following specifications for the connection to this connector.

The tally lamp can be lit by shorting the TALLY signal (pin 2) with GND (pin 1).

<NOTE>

• Do not apply a voltage to the TALLY signal pin.

LAN cable*1(category 5 or above, straight cable), max. 1000 m (3280 ft)

*1 Use of an STP (shielded twisted pair) cable is recommended.

Bottom panel

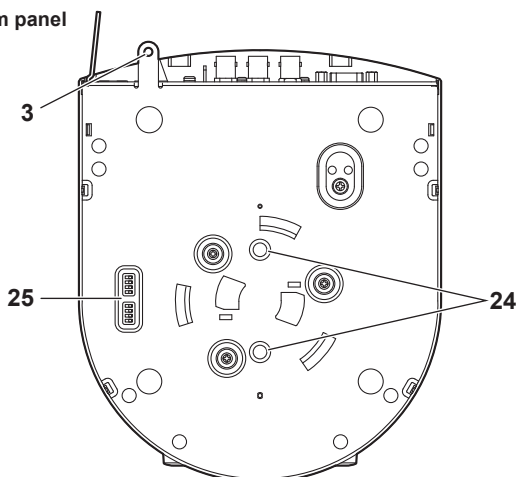

Pin No.	Signal	Pin No.	Signal
1	GND	5	TXD+
2	TALLY	6	RXD+
3	RXD-	7	—
4	TXD-	8	—

Parts and their functions (continued)

10.RS-232C connectors <RS-232C IN/OUT>

Connects to an RS-232C cable.

RS-232C IN/OUT connector appearance

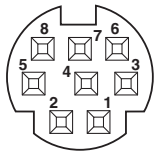

Mini Din 8-pin (JST)

RS-232C IN		RS-232C OUT	
Pin No.	Signal	Pin No.	Signal
1	DTR_IN	1	DTR_OUT
2	DSR_IN	2	DSR_OUT
3	TXD_IN	3	TXD_OUT
4	GND	4	GND
5	RXD_IN	5	RXD_OUT
6	GND	6	GND
7	IR OUT R	7	NC
8	IR OUT L	8	NC

<NOTE>

- Be aware that the polarities (+/-) of the serial data may be different depending on the specifications of the device to be connected.

11.LAN connector for IP control <LINK/ACT>

This LAN connector (RJ45) is connected when exercising IP control over the unit from an external device. Use a cable with the following specifications for the connection to this connector.

When using a PoE+ Ethernet hub

LAN cable*1 (category 5e or above, straight cable), max. 100 m (328 ft)

When not using a PoE+ Ethernet hub

LAN cable*1 (category 5 or above, straight cable), max. 100 m (328 ft)

*1 Use of an STP (shielded twisted pair) cable is recommended.

12.HDMI connector <HDMI>

This is the HDMI video output connector.

13.Anti-theft wire mounting hole

The anti-theft wire bracket (available from a hardware store) is attached here.

14.G/L IN connector <G/L IN>

This is the external sync signal input connector.

This unit supports BBS (Black Burst Sync) and tri-level synchronization.

Supply to this connector the signals that correspond to the video signal format which has been set.

Format	External sync signal input format	
	BBS	Tri-level sync
1080/59.94p	480/59.94i	1080/59.94i
1080/29.97p	480/59.94i	—
1080/23.98p	480/59.94i	1080/59.94i
1080/59.94i	480/59.94i	1080/59.94i
1080/29.97PsF	480/59.94i	1080/59.94i
1080/23.98PsF	—	1080/23.98PsF
720/59.94p	480/59.94i	720/59.94p
480/59.94p(i)	480/59.94i	—
1080/50p	576/50i	1080/50i
1080/25p	576/50i	—
1080/50i	576/50i	1080/50i
1080/25PsF	576/50i	1080/50i
720/50p	576/50i	720/50p
576/50p(i)	576/50i	—

<NOTE>

- Locking to a subcarrier is not possible with BBS.

15.VIDEO OUT connector <VIDEO OUT>

This is the output connector used for monitoring the camera's composite video signals. Use the monitor in the internal synchronization mode.

Provide a BNC coaxial cable as the connecting cable.

There is a delay in the VIDEO OUT signal output by 120H (HD lines) when at 720p and by 90H (HD lines) for any other.

16.Hole used to secure cable cover

Use the screw provided to secure the cable cover.

17.SDI OUT connector <SDI OUT>

This is the SDI video signal output connector.

18.DC IN connector <12V $\overline{\text{DC}}$ IN $\ominus \oplus$ >

Connect the AC adaptor supplied with the unit to this connector to supply the DC 12 V voltage to the unit.

19.Cable clamp

This is used to hold the cable connection to the DC IN connector and prevent it from becoming disconnected.

20.IR ID switches <IR ID>

CAM1	CAM2	CAM3	CAM4
IR ID	IR ID	IR ID	IR ID

These are used to select the ID of the wireless remote control (optional accessory).

The IR ID switch settings "CAM1" to "CAM4" correspond to the <CAM1> to <CAM4> buttons on the wireless remote control.

21.Square holes (X2) for cable cover tabs

The tabs on the two sides of the cable cover are fitted into these holes.

22.AUDIO IN connector <AUDIO IN>

Inputs external audio (microphone, line).

23.Ground connector

Connects to the ground connector on a wall outlet, ground bar, etc. for grounding. "Note on grounding" (→ page 7)

24.Tripod screw holes

(Screw: 1/4-20 UNC, ISO 1222 (6.35 mm))

Use these screw holes when securing the unit to a tripod, etc.

25.Service switches

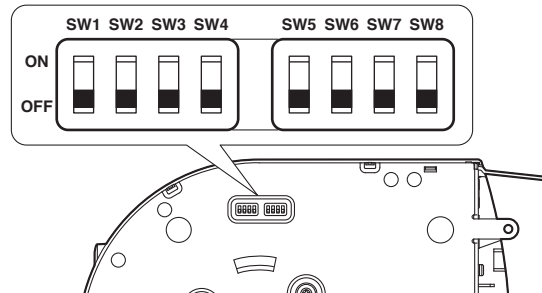

Function		OFF	ON	Factory settings
SW1	Camera address setting (standard serial communication)	See descriptions for SW1 to SW3		OFF
SW2				OFF
SW3				OFF
SW4	Communication format	Panasonic proprietary serial communication	Standard serial communication	OFF
SW5	Always leave at OFF (used for factory adjustments)			OFF
SW6	Infrared output	Disable	Enable	OFF
SW7	Communication baud rate	9600 bps	38400 bps	OFF
SW8	Communication connector	RS-422	RS-232C	OFF

<NOTE>

- Perform switch settings before turning the unit on.
- Cameras whose camera address setting switches are set to AUTO cannot coexist with cameras whose switches are set to 1 to 7.
- Manually setting multiple cameras to the same address will not allow you to control multiple cameras from a single controller simultaneously.

Parts and their functions (continued)

Service switch settings

SW1 to SW3 (camera address setting switches)

Configure the camera address.

Set this to AUTO under normal circumstances. When cameras are set to AUTO, addresses will be assigned to the cameras automatically in response operation from the controller in the order in which the cameras were connected.

To manually configure the address, set the switches as follows.

Address	AUTO	1	2	3	4	5	6	7
SW1	OFF	ON	OFF	ON	OFF	ON	OFF	ON
SW2	OFF	ON	ON	OFF	OFF	ON	ON	OFF
SW3	OFF	ON	ON	ON	ON	OFF	OFF	OFF

SW4 (communication format selection switch)

Selects the communication format.

When this is set to ON, standard serial communication is enabled.

When this is set to OFF, Panasonic's proprietary serial communication is enabled.

SW5 (maintenance switch)

Fixed at OFF.

Do not change this switch setting.

SW6 (infrared output switch)

When this is set to ON, infrared output is enabled. The signal received via the remote control sensor is output from pins 7 and 8 of the <RS-232C IN> connector.

Signal output is disabled when this is set to OFF.

SW7 (communication baud rate switch)

When this is set to ON, the baud rate is 38400 bps.

When this is set to OFF, the baud rate is 9600 bps.

SW8 (communication connector switch)

When this is set to ON, the RS-232C is enabled.

When this is set to OFF, the RS-422 is enabled.

■ Simultaneous output conditions for each video format

● SDI/HDMI/VIDEO output

	Format	SDI output	HDMI output	VIDEO output*4
HD/SDI	1080/59.94p	✓	✓	✓
	1080/50p	✓	✓	✓
	1080/59.94i	✓	✓	✓
	1080/50i	✓	✓	✓
	1080/29.97PsF	✓*1		✓
	1080/25PsF	✓*2		✓
	1080/23.98PsF	✓		✓
	1080/29.97p*3	✓	✓	✓
	1080/25p*3	✓	✓	✓
	1080/23.98p	✓*1	✓	✓
	720/59.94p	✓	✓	✓
	720/50p	✓	✓	✓
SD/SDI	480/59.94p		✓	
	576/50p		✓	
	480/59.94i	✓		✓
	576/50i	✓		✓

*1 OVER 59.94i output (your monitor may recognize the signal as 59.94i).

*2 OVER 50i output (your monitor may recognize the signal as 50i).

*3 Native output

*4 480/59.94i and 576/50i is output to the VIDEO output regardless of the format setting.

● IP video transmission output (1-/multi-channel display)

1-channel display		
Resolution	1920×1080 / 1280×720 / 640×360 / 320×180 / 160×90 (non-dependent on SYS format)	
Frame rate	59.94Hz	1 fps/2 fps/3 fps/5 fps/6 fps/10 fps/15 fps/30 fps/60 fps*1
	50Hz	1 fps/2 fps/5 fps/10 fps/12.5 fps/25 fps/50 fps*2

*1 60 fps only during H.264 transmission and 1920×1080 or 1280×720 resolution

*2 50 fps only during H.264 transmission and 1920×1080 or 1280×720 resolution

Multi-channel display				
Setting	H.264 CH1	H.264 CH2	H.264 CH3/CH4	JPEG CH1/CH2/CH3*3
Resolution	1920×1080 1280×720	1920×1080 1280×720 640×360 320×180 160×90	1280×720 640×360 320×180 160×90	1920×1080 1280×720 640×360 320×180 160×90
Frame rate	59.94Hz	60fps	5 fps 15 fps 30 fps	1 fps 2 fps 3 fps 5 fps 6 fps 10 fps 15 fps 30 fps
	50Hz	50 fps	5 fps 12.5 fps 25 fps	1 fps 2 fps 5 fps 10 fps 12.5 fps 25 fps

*3 Different resolutions must be specified for JPEG CH1 / CH2 / CH3.

Wireless remote control (not supplied)

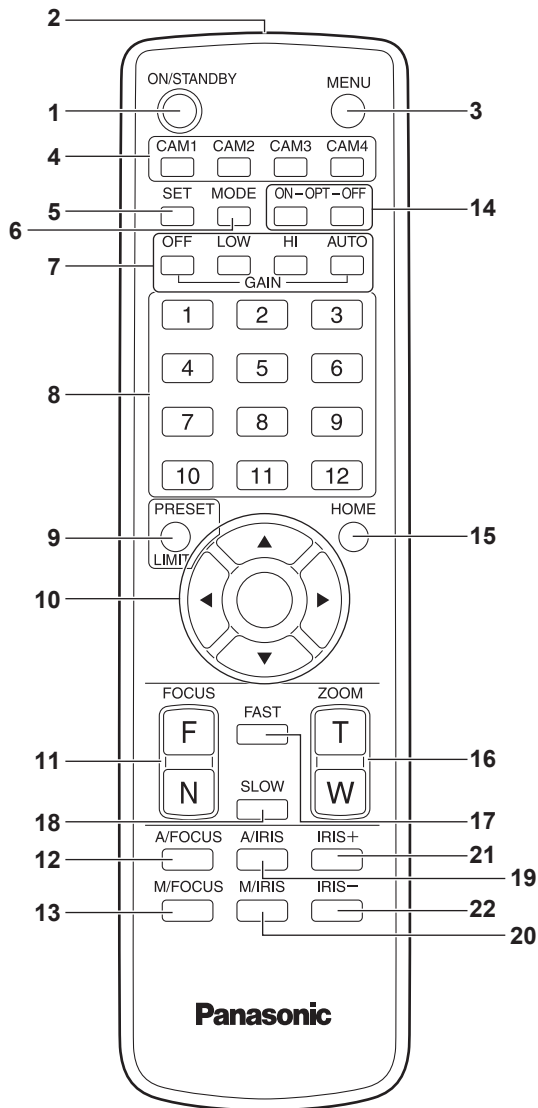

1. ON/STANDBY button <ON/STANDBY>

Each time this is pressed for 2 seconds, operation switches between turning on the unit's power and establishing the standby status.

2. Signal transmission window

3. MENU button <MENU>

Each time this is pressed for 2 seconds, operation switches between displaying the unit's camera menu and exiting the camera menu. When it is pressed quickly (for less than 2 seconds) while a camera menu is displayed, the setting change is canceled. Furthermore, the pan and tilt movement range limits (limiters) are set and released by operating the <PRESET/LIMIT> button and the pan/tilt buttons (<▲> <▼> <◀> <▶>). For details, refer to "Setting/releasing the limiters" (→ page 110).

4. CAM1 to CAM4 buttons

<CAM1> <CAM2> <CAM3> <CAM4>

Selects a camera to be operated. Once a button has been selected, the unit corresponding to the selected button can be operated.

5. SET button <SET>

If this button is held down for 2 seconds when the AWB A memory or AWB B memory has been selected for the white balance adjustment, the black balance and white balance are adjusted automatically and registered in the memory selected. When this button is pressed for under 2 seconds, only the white balance is adjusted automatically.

6. MODE button <MODE>

This is used to select the video signals which are output from the unit. Each time it is pressed, the signals are switched between the color bar signals and camera video signals.

<NOTE>

- The setting for the [Down CONV. Mode] item when color bars are displayed is fixed at [Squeeze].
- When [Audio] is set to [On] and the color bar is displayed, a test sound (1 kHz) is output. Be cautious of the volume on external devices.

7. GAIN button <OFF> <LOW> <HI> <AUTO>

These are used to set the gain. The gain increase can be set in three steps using the <OFF>, <LOW> and <HI> buttons. <LOW> is set to 9 dB, and <HI> is set to 18 dB. When the <AUTO> button is pressed, the AGC function is activated, and the gain is adjusted automatically depending on the light quantity. The maximum gain of the AGC function can be set using the camera menu.

8. Preset memory call buttons <1> to <12>

These are used to call the information on the unit's directions and other settings, which have been registered in the unit's preset memories No.1 to No.12, and reproduce those settings. Settings in preset memories No.13 and above cannot be called from the wireless remote control.

9. PRESET/LIMIT button <PRESET/LIMIT>

This is used to register the settings in the preset memories or set or release the limiters. When a preset memory call button is pressed while the <PRESET/LIMIT> button is held down, the information on the unit's current direction and other settings is registered in the call button. Preset memory call buttons <1> to <12> correspond to the unit's No.1 to No.12 preset memories. Furthermore, the pan and tilt movement range limits (limiters) are set and released by operating the <PRESET/LIMIT> button, <MENU> button and the pan/tilt buttons (<▲> <▼> <◀> <▶>). For details, refer to "Setting/releasing the limiters" (→ page 110).

10. Pan-tilt buttons and menu operation buttons

<▲> <▼> <◀> <▶> <○>

- 1) These are used to change the unit's direction. The unit is tilted in the up/down direction using the <▲> and <▼> buttons and panned in the left/right direction using the <◀> and <▶> buttons. The <○> button does not work during tilting and panning. When the <▲> or <▼> and <◀> or <▶> buttons are pressed at the same time, the unit moves diagonally.
- 2) The buttons are used for menu operations when the unit displays the camera menus. Use the <▲>, <▼> (<◀>, <▶>) buttons to select the menu items. When a selected item has a sub-menu, the sub-menu will be displayed by pressing the <○> button. When the cursor is aligned with a particular item and the <○> button is pressed on the setting menu at the bottom hierarchical level, the setting of the selected item blinks. When the <○> button is pressed after the setting has been changed using the <▲> and <▼> (<◀> and <▶>) buttons, the setting stops blinking, and the new setting is entered. A setting for a regular menu item is reflected immediately if it is changed while it is still flashing. If the <MENU> button is pressed quickly (for less than 2 seconds) while the setting is in the blinking status, the change will be canceled, and the setting selected prior to the change will be restored.

<NOTE>

- To prevent malfunctioning, there are a number of menu items ([Scene], [Format], [Down CONV. Mode] and [Frequency]) whose setting is not reflected immediately even if it is changed while it is still flashing.
It is reflected only after the <O> button has been pressed, causing the setting to stop flashing and the new setting to be entered.
- A confirmation screen appears before the settings of some menu items are to be entered.

11.FOCUS button <F> <N>

These are used to adjust the lens focus manually when the manual setting is established for the lens focus.
The focus is adjusted in the far using the <F> button and in the near using the <N> button.

12.A/FOCUS button <A/FOCUS>

This is used when automatically adjusting the lens focus.

13.M/FOCUS button <M/FOCUS>

This is used when manually adjusting the lens focus.
The FOCUS buttons (<F> and <N>) are used when performing the actual adjustment.

14.OPT button <ON> <OFF>

Turn night mode on/off.

<NOTE>

- In night mode, video output will be in black and white. In addition, the iris will be forcibly opened.
- White balance adjustment is not possible in night mode.
- ND filter switching is not possible in night mode.

15.HOME button <HOME>

When this is pressed for 2 seconds, the unit's direction (panning or tilting) returns to the reference position.

16.ZOOM button <T> <W>

These are used to adjust the lens zoom.
The zoom is adjusted in the wide-angle using the <W> button and in the telephoto using the <T> button.

17.FAST button <FAST>

This is used to change the movement speed at which the panning, tilting, zooming and focusing operations are performed to the high speed.

<NOTE>

- The operating speed for panning and tilting when the preset memory settings have been called can be changed using the "Preset Speed" item of the camera menu.

18.SLOW button <SLOW>

This is used to change the movement speed at which the panning, tilting, zooming and focusing operations are performed to the low speed.

19.A/IRIS button <A/IRIS>

This establishes the setting for adjusting the lens iris automatically in line with the light quantity.

20.M/IRIS button <M/IRIS>

This establishes the setting for adjusting the lens iris manually.
The <IRIS +> and <IRIS -> buttons are used when performing the actual adjustment.

21.IRIS + button <IRIS +>

This is used to adjust the lens iris in the opening direction.

22.IRIS - button <IRIS ->

This is used to adjust the lens iris in the closing direction.

Setting the remote control IDs

The wireless remote control (optional accessory) is capable of operating up to four units.

IDs are used to set which units are selected when the <CAM1>, <CAM2>, <CAM3> and <CAM4> buttons on the wireless remote control have been pressed.

- When operating a multiple number of these units using wireless remote controls, set a different remote control ID for each control.
- When using one unit, set the remote control ID to “CAM1” unless the setting needs to be changed.

■ Setting procedure

Operate the IR ID switches on the unit's rear panel, and select “CAM1”, “CAM2”, “CAM3” or “CAM4” as the remote control ID. (→page 18)

The IR ID switch settings “CAM1” to “CAM4” correspond to the <CAM1> to <CAM4> buttons on the wireless remote control.

(The factory setting is “CAM1”.)

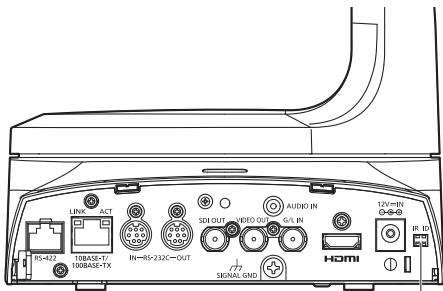

IR ID switches

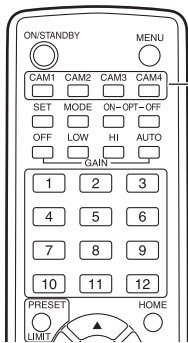

<CAM1> to <CAM4> buttons

Network settings

Installing the software

Visit the product support desk of the following website to download the software. [Windows](#)
<https://pro-av.panasonic.net/>

● Easy IP Setup Software (EasyIPSetup.exe)

This software establishes the unit's network settings. For details, refer to the sections that follow.

● Plug-in viewer software installer (nwcV4SSetup.exe)

Install the plug-in software (Network Camera View 4S) required to view IP images from the unit on a web browser. For details, see the following.

Use the Easy IP Setup Software to establish the unit's settings

The settings related to the unit's network can be established using the Easy IP Setup Software.

To establish the settings for a multiple number of units, the settings must be selected for each camera involved.

If the settings cannot be established using the Easy IP Setup Software, select the settings separately for the unit and personal computer on the Network setup screen [Network] of the setting menu. (→ page 89)

<NOTE>

- If, after the network settings have been established, another device in the same network has the same IP address, the network operations will not be performed properly.
Set the IP address in such a way that it does not duplicate an existing IP address.
- Do not establish network settings from a multiple number of Easy IP Setup Software programs at the same time for a single camera. Similarly, do not perform the "Auto IP setting" operation of the AW-RP50 remote camera controller at the same time.
The IP address settings may no longer be recognized as a result.
- The Easy IP Setup Software cannot be used from a different subnet via a router.
- Use Easy IP Setup Software ver. 4.25R00 or newer.

1. Start the Easy IP Setup Software.

2. Click the [Search] button.

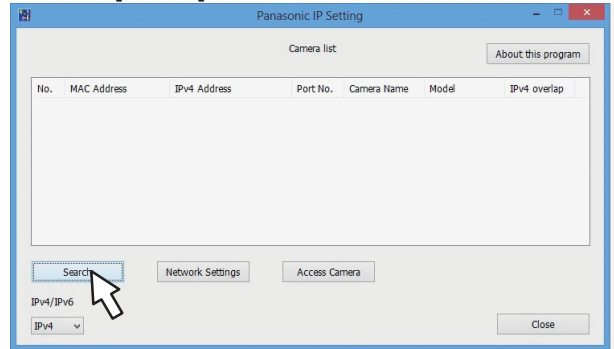

3. Click the MAC address/IPv4 address of the camera to be set, and click the [Network Settings] button.

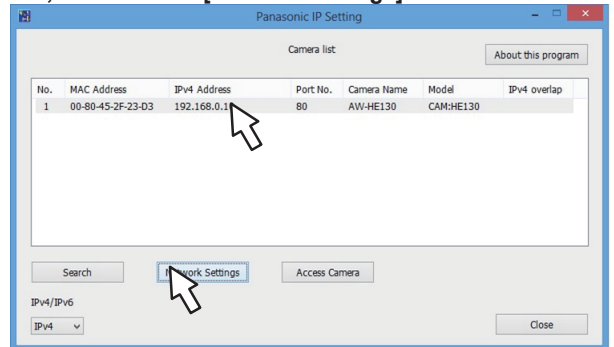

<NOTE>

- When a DHCP server is being used, the IP address allocated to the unit can be checked by clicking the [Search] button of the Easy IP Setup Software.
- If the same IP address is used for any additional cameras, the numbers of the additional cameras will be displayed in the [IPv4 overlap] column of the cameras concerned.
- When the [Access Camera] button is clicked, the Live screen of the selected camera is displayed.
- This unit does not support an IPv4/IPv6 switching function.

4. Input the network items, and click the [Save] button.

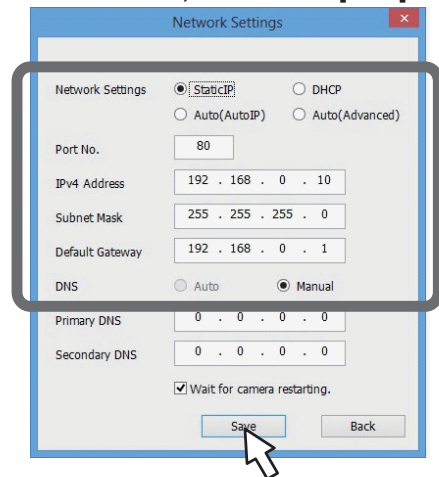

<NOTE>

- When a DHCP server is being used, [DNS] of the Easy IP Setup Software can be set to [Auto].
- After the [Save] button is clicked, it takes about 2 minutes for the settings in the unit to be completed. If the AC adaptor or LAN cable is disconnected before the settings are completed, the settings will be canceled. In this case, repeat the steps to establish the settings.
- When a firewall (including software) has been introduced, enable access to all the UDP ports.

Installing the plug-in viewer software

To view IP images from the unit on a web browser, the "Network Camera View 4S" plug-in viewer software (ActiveX®) must be installed.

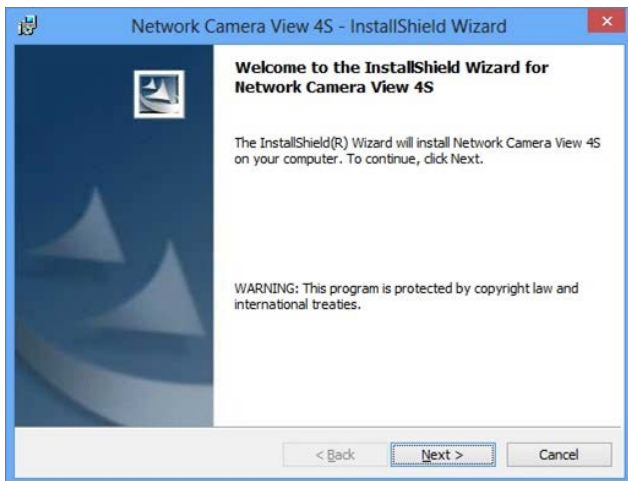

<NOTE>

- [Automatic installation of viewer software] is set to [On] at the time of purchase, allowing you to install directly from the unit. If a message appears in the web browser's information bar, see page 120.
- When you display the Live screen [Live] on the personal computer for the first time, the installation screen for the plug-in viewer software (ActiveX) appears. Follow the instructions on the screen to perform installation.
- If the plug-in viewer software (ActiveX) installation screen continues to appear when switching screens, even after it is installed, restart the personal computer.
- A license is required for the plug-in viewer software for each personal computer on which it is installed. You can view the number of times the plug-in viewer software was automatically installed in the [Product info.] tab of the Maintenance screen [Maintenance] (→ page 101). For details on licenses, consult your local dealer.
- To uninstall the plug-in viewer software, select [Control Panel] - [Programs] - [Uninstall a program] in Windows, and remove "Network Camera View 4S".

About the Upgrades of the AW-HE130 Firmware

Starting from firmware version 2.20, AW-HE130 can transmit video to an NDI enabled software application or hardware device, which ensures full compatibility with NewTek NDI over a network.

This mode needs to be activated by NewTek, Inc. before actual use. Contact NewTek, Inc. for more details. (Contact address: http://new.tk/ndi_panasonic)

To prevent unauthorized access to cameras

Enable the user authentication function

(Not available when the AW-RP50 is connected)

Remote cameras can be configured to allow access from the Internet. To prevent infringement of privacy and personality rights, information leaks, and other issues concerning unauthorized access by third parties, we recommend enabling the user authentication function upon installation.

Note:

- The user authentication function for cameras is not available when the AW-RP50 is connected.
- Although the user authentication function for cameras is available when the AW-RP120 or AK-HRP200 is connected, only basic authentication will be available.

Configuration example (refer to the operating instructions provided with your camera for further information about the settings used for your camera)

- ① Turn on user authentication
- ② Set a new user name and password
- ③ Delete the default user name

Preparation:

1. Startup the web browser and display the "Live" page on a PC.
2. Click "Setup" button and then click "User mng." button.

The user authentication window will be displayed.

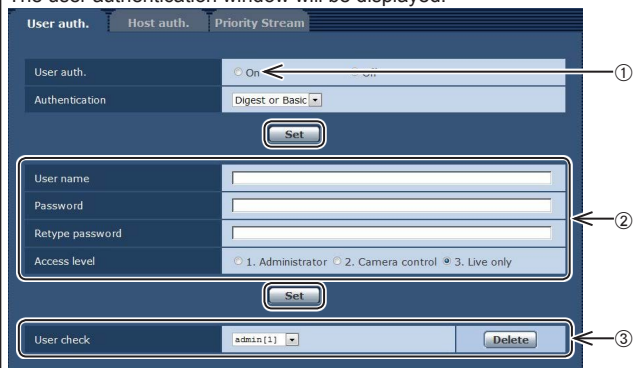

① Select "On" for "User auth."

- * Set to "Off" by default.
- ⇒ Then click "Set" button.

② Register a new user name and password

- * Select "1. Administrator" for the access level.
- ⇒ Then click "Set" button.

③ Delete the default user name.

- ⇒ Click the "Delete" button after selecting the user name to be deleted ("admin[1]").

* Depending on the model used, the screens shown in the explanations may differ to the actual camera screens.

User name and password management

- **Use a combination of characters and numbers that is difficult to guess.**
Avoid using a string of the same characters, such as "11111", birth dates, or telephone numbers.
For details on valid characters and lengths, refer to "User authentication screen" (→ page 87).
- **Change user names and passwords periodically.**
- **Make sure to manage the configured user names and passwords.**
- **Delete all user names that do not have an assigned user.**

After changing the user name/password

Also change the user names and passwords registered to the following. Refer to the operating instructions provided with your camera for further information about the settings used for your camera.

- AW-RP120 remote camera controller (AW-RP50 not supported)
- AK-HRP200 remote operation panel
- Browsers and applications on computers, tablets, and smartphones.

Basic shooting operations

1. Set the subject brightness to the appropriate level.
2. Turn on the power of all the units and devices in the system.

3. Select the unit to be operated.

Even when using only one unit, it must still be selected from the wireless remote control or controller.

4. Select the shooting mode.

One of four shooting modes (Scene1, Scene2, Scene3 or Scene4) — whichever one will best suit the shooting conditions — can be selected.

The shooting modes are set by the user.

For details of the factory settings, refer to pages 60 to 62.

Select the mode that satisfies the shooting conditions and suits your preferences.

When continuing to shoot in the same circumstances, there is no need to select another mode.

5. Start shooting.

(After shooting, turn off the power of all the units and devices in the system.)

<NOTE>

- Some of the initial settings are auto settings and cannot be operated manually. To operate them manually, switch from the auto settings to the manual settings as required.

If the settings have already been changed and the original settings are to be restored, refer to the “What to do when encountering problems in the basic shooting operations” (→ page 29) and “Camera screen” (→ page 47) in “Camera menu items”.

How to turn the power on and off

Turning the power on

When performing operations from a wireless remote control

1. Set all the power switches of the units and devices connected in the system to ON.

- This unit does not have a power switch.

When power is supplied to it, the status display lamp will light orange, and the unit is set to the Standby mode.

<NOTE>

- Under factory default conditions, the unit will be in Standby mode when power is supplied for the first time. (Status display lamp: Lit orange)
- When the power supply is cut off while the unit is in Standby mode, the unit will be in Standby mode the next time power is supplied. (Status display lamp: Lit orange)
- When the power supply is cut off while the unit is in Power ON mode, the unit will be in Power ON mode the next time power is supplied. (Status display lamp: Lit green)

2. Press one of the <CAM1> to <CAM4> buttons on the wireless remote control to select the unit.

3. Press the <ON/STANDBY> button on the wireless remote control for 2 seconds.

The Power ON mode is established, images are output, and control can be exercised.

- The unit's status display lamp now lights up green.

<NOTE>

- It takes maximum 30 seconds per unit for the initial settings operation to be completed. During this period, the unit cannot be operated. (Status display lamp: Lit orange)

4. If a multiple number of units are going to be used, repeat steps 2 and 3 as required.

The unit's status display lamp blinks green when a signal matched by the remote control ID has been received, and it blinks orange when a signal that is not matched by the remote control ID has been received.

<NOTE>

- When operation is transferred to the Standby mode: The current zoom, focus and iris positions are stored in the memory (Power ON preset).
- When operation is transferred to the Power ON mode: The zoom, focus and iris are adjusted to the positions which were stored in the memory (Power ON preset) when operation was transferred to the Standby mode.

When performing operations from a controller

When using an AW-RP50, AW-RP120, or AK-HRP200

Refer to the operating instructions for the controller.

When using a commercially available controller

Refer to the operating instructions for the controller.

Turning the power off

When performing operations from a wireless remote control

1. Press one of the <CAM1> to <CAM4> buttons on the wireless remote control to select the unit.

2. Press the <ON/STANDBY> button on the wireless remote control for 2 seconds.

The unit enters Standby mode.

- The unit's status display lamp lights orange during this time.

3. If a multiple number of units are going to be used, repeat steps 1 and 2 as required.

4. Set all the power switches of the units and devices connected in the system to OFF.

- This unit does not have a power switch.

<NOTE>

- When operation is transferred to the Standby mode: The current zoom, focus and iris positions are stored in the memory (Power ON preset).
- When operation is transferred to the Power ON mode: The zoom, focus and iris are adjusted to the positions which were stored in the memory (Power ON preset) when operation was transferred to the Standby mode.

When performing operations from a controller

When using an AW-RP50, AW-RP120, or AK-HRP200

Refer to the operating instructions for the controller.

When using a commercially available controller

Refer to the operating instructions for the controller.

Selecting the units

Up to four units can be operated using one wireless remote control.

Up to five units can be operated using one controller.

Select the unit (or units) to be operated from the wireless remote control or controller.

Even when using only one unit, it must still be selected.

When performing operations from a wireless remote control

To select the unit using the wireless remote control, the IR ID switches on the unit's back panel must be set.

For details of the IR ID switch settings, refer to page 18 and page 22.

1. Press the <CAM1>, <CAM2>, <CAM3>, or <CAM4> button.

The unit's status display lamp blinks green when a signal matched by the remote control ID has been received, and it blinks orange when a signal that is not matched by the remote control ID has been received.

When performing operations from a controller

When using an AW-RP50, AW-RP120, or AK-HRP200

Refer to the operating instructions for the controller.

Selecting the shooting modes (scene files)

Types of shooting modes

One of four shooting modes (Scene1, Scene2, Scene3 or Scene4) — whichever one will best suit the shooting conditions — can be selected. The shooting modes are set by the user. For details of the factory settings, refer to pages 60 to 62. Select the mode that satisfies the shooting conditions and suits your preferences. The settings can be changed by menu operations.

- The results of the white balance and other adjustments are stored in the memory separately by shooting mode. Be absolutely sure to select the shooting mode before making any adjustments.

<NOTE>

- Some of the initial settings are auto settings and cannot be operated manually. To operate them manually, switch from the auto settings to the manual settings as required.

Scene1
Scene2
Scene3
Scene4

The settings of your preferences can be established in line with the shooting scene, lighting and other conditions.

How to select the shooting mode

When performing operations from a wireless remote control

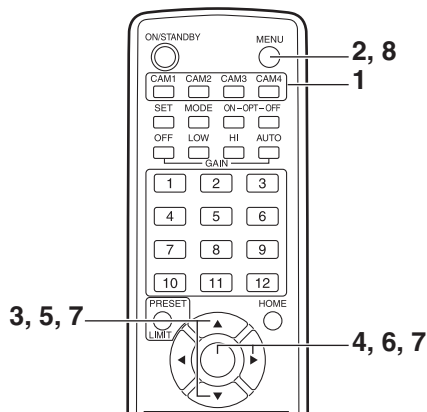

- Press the <CAM1>, <CAM2>, <CAM3> or <CAM4> button to select the unit.
- Press and hold the <MENU> button for about 2 seconds. The Top Menu is displayed.

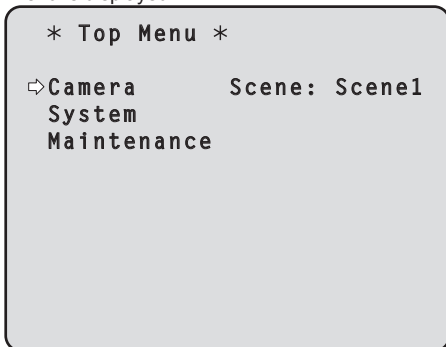

- Press the <▲> or <▼> button to bring the cursor to [Camera].

- Press the <○> button.

The [Camera] sub-menu is displayed on the monitor.

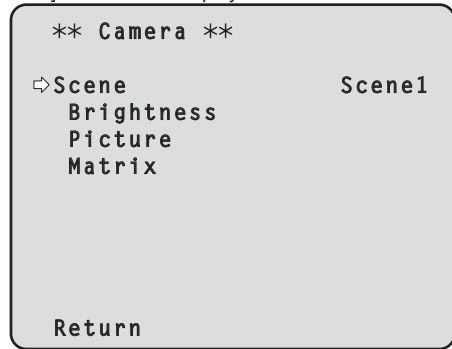

- Press the <▲> or <▼> button to bring the cursor to [Scene].

- Press the <○> button.

The shooting mode blinks.

- Press the <▲> or <▼> button to select the shooting mode (Scene1, Scene2, Scene3 or Scene4) to be used, and press the <○> button to enter the selection.

- Press and hold the <MENU> button for about 2 seconds.

The camera menu display is exited.

When performing operations from a controller

When using an AW-RP50, AW-RP120, or AK-HRP200

Refer to the operating instructions for the controller.

Shooting

When performing operations from a wireless remote control

■ Changing the camera's direction

Moving the camera toward the left or right (panning):

Press the <◀> or <▶> button.

Moving the camera up or down (tilting):

Press the <▲> or <▼> button.

Moving the camera diagonally:

Press the <▲> or <▼> button and <◀> or <▶> button at the same time.

Returning the camera to the reference position:

Press the <HOME> button for 2 seconds.

■ Using the zoom function

Zooming in (the subject becomes magnified in size):

Press the <T> button of <ZOOM>.

Zooming out (the subject becomes reduced in size):

Press the <W> button of <ZOOM>.

■ Switching the panning/tilting and lens operation speed

Changing the direction or zoom at high speed:

Press the <FAST> button.

Changing the direction or zoom at low speed:

Press the <SLOW> button.

The speeds at which the pan, tilt, zoom, focus and iris are controlled are now switched.

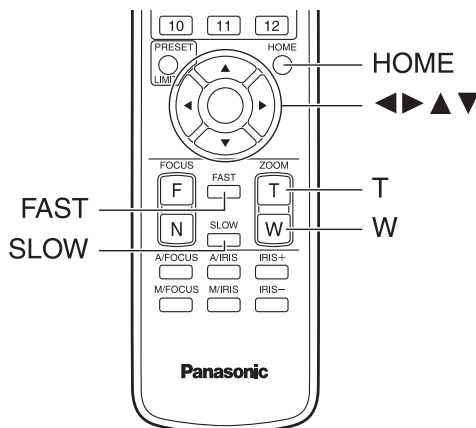

When performing operations from a controller

■ Changing the camera's direction

Moving the camera toward the left or right (panning):

Tilt the <PAN/TILT> lever toward L or R.

Moving the camera up or down (tilting):

Tilt the <PAN/TILT> lever toward UP or DOWN.

Moving the camera diagonally:

Tilt the <PAN/TILT> lever diagonally.

■ Using the zoom function

Zooming in (the subject becomes magnified in size):

Tilt the <ZOOM> lever toward the TELE direction.

Zooming out (the subject becomes reduced in size):

Tilt the <ZOOM> lever toward the WIDE direction.

■ Switching the panning/tilting and lens operation speed

When using an AW-RP50, AW-RP120, or AK-HRP200

Refer to the operating instructions for the controller.

What to do when encountering problems in the basic shooting operations

If the trouble is not resolved by taking the action suggested below, refer to "Troubleshooting" (→ page 112).

When performing operations from a wireless remote control

The unit does not move.

- Press the <CAM1>, <CAM2>, <CAM3> or <CAM4> button to select the unit which is to be operated.
If only one unit is being used, it is normally selected using the <CAM1> button.
- Check that the IR ID switches have been set correctly. (→page 18, page 22)
- If the unit's status display lamp is off or lights up orange, it means that the unit's power is not on.
Refer to "Turning the power on" (→ page 25), and turn on the power.
- If the unit's status display lamp does not blink even when the wireless remote control is operated near the unit's wireless remote control signal light-sensing area, it means that the wireless remote control's batteries have run down.
Replace the batteries.

Multiple color bands (color bars) are displayed.

Switch to the camera image by pressing the <MODE> button.

The menu screen is displayed.

Press the <MENU> button for 2 seconds to exit the camera menu.

The lens focus is not adjusted automatically.

Press the <A/FOCUS> button to switch to auto focusing.

The camera picture is too light or too dark.

- Press the <A/IRIS> button to switch the lens iris adjustment to auto.
- Press the <AUTO> button of <GAIN> to switch the gain adjustment to auto.

Something is wrong with the coloring of the camera pictures.

Refer to "Auto tracking white adjustment (ATW)" (→ page 33), and switch to "ATW".

The camera menus are not displayed.

If any of the camera menus are displayed within less than a minute after the camera was restarted, the menus will be displayed in all the outputs. Check [OSD Mix] (→ page 57) on the camera menu [Others 3/4] screen.

More advanced operations

Manual shooting (→ page 30)

- Manually adjusting the focus
- Manually adjusting the iris
- Manually adjusting the shutter speed
- Manually adjusting the gain

Preset memories (→ page 31)

- Up to 100 settings for the camera direction (panning and tilting), zoom, focus, iris, gain up and white balance can be registered in the preset memories, and called.
- The number of settings that can be registered and called depends on the type of wireless remote control (12 settings) or controller that is used for operation.

White balance adjustment (→ pages 32 to 33)

- This adjustment is performed to express the white accurately. Its setting also has an effect on the color tones of the entire screen.
- It must be performed when using the unit for the first time or when the unit has not been used for a prolonged period.
- Perform adjustment when the lighting conditions or brightness changes.
- Once the white balance has been attained, no further adjustment is required provided that the unit is going to be used under the same conditions.
- White balance adjustment is not possible in night mode.

When performing operations from a controller

The unit does not move.

- Select the unit to be operated by following the procedure below.
When using an AW-RP50, AW-RP120, or AK-HRP200
Refer to the operating instructions for the controller.

- If the unit's status display lamp is off or lights up orange, it means that the unit's power is not on.
Refer to "Turning the power on" (→ page 25), and turn on the power.

Multiple color bands (color bars) are displayed.

Switch to the camera image by pressing the <BARS> button.

The menu screen is displayed.

Press the <CAMERA OSD> button to exit the camera menu.

The lens focus is not adjusted automatically.

Press the <AUTO> button of <FOCUS> to switch to auto focusing.

The camera picture is too light or too dark.

- Press the <AUTO> button of IRIS to switch the lens iris adjustment to auto.
- Press the <AUTO> button of GAIN to switch the gain adjustment to auto.

Something is wrong with the coloring of the camera pictures.

Refer to "Auto tracking white adjustment (ATW)" (→ page 33), and switch to "ATW".

The camera menus are not displayed.

If any of the camera menus are displayed within less than a minute after the camera was restarted, the menus will be displayed in all the outputs. Check [OSD Mix] (→ page 57) on the camera menu [Others 3/4] screen.

Manual shooting

Manually adjusting the focus

The lens focus can be adjusted manually.

When performing operations from a wireless remote control

1. Press the <M/FOCUS> button to switch the focus to manual adjustment.
2. Press the <F> or <N> button of <FOCUS> to adjust the focus.
When the <F> button is pressed, the focus moves further away (far); conversely, when the <N> button is pressed, it moves nearer (near). The speed of focusing and other adjustments can be switched to fast or slow by pressing the <FAST> or <SLOW> button, respectively.
3. If necessary, press the <A/FOCUS> button to return the focus to the automatic adjustment.

When performing operations from a controller

When using an AW-RP50, AW-RP120, or AK-HRP200

Refer to the operating instructions for the controller.

<NOTE>

- When the focus is set to manual, the subject may go out of focus during panning, tilting and zooming. Therefore, the unit comes with a function which compensates for this. (Focus ADJ With PTZ.) This function was set to [On] at the factory. If the function has been set to [Off], either adjust the focus, as required, after zooming or set the focus to auto. (→page 56, page 82, page 85)

Manually adjusting the iris

The lens iris can be adjusted manually.

When performing operations from a wireless remote control

1. Press the <M/IRIS> button to switch the iris to manual adjustment.
2. Adjust the iris using the <IRIS +> or <IRIS -> button.
Press the <IRIS +> button to adjust the lens iris in the opening direction; conversely, press the <IRIS -> button to adjust the lens iris in the closing direction.
The speed of the iris and other adjustments can be switched to fast or slow by pressing the <FAST> or <SLOW> button, respectively.
3. If necessary, press the <A/IRIS> button to return the iris to the automatic adjustment.

When performing operations from a controller

When using an AW-RP50, AW-RP120, or AK-HRP200

Refer to the operating instructions for the controller.

<NOTE>

- In the night mode, the iris is set to open as a measure to prevent video spying.
Adjust the brightness at the light source.

Manually adjusting the shutter speed

The shutter speed can be set using two methods. One is a method that specifies the time (where a time such as 1/250 sec. is designated), and the other is a method that specifies the frequency (where synchro scan, 60.15 Hz, etc. is designated).

When shooting a TV screen or personal computer's monitor screen, the horizontal noise generated when the screen is shot can be minimized by adjusting the frequency to the screen frequency using synchro scan.

When performing operations from a wireless remote control

Perform the adjustments on the Camera menu.

For further details, refer to the [Shutter Mode] (→ page 47) and [Step/Synchro] (→ page 47).

When performing operations from a controller

The procedure is the same as for "When performing the operations using the wireless remote control" in "Basic setup operations" (→pages 37 to 45).

When using an AW-RP50, AW-RP120, or AK-HRP200

Refer to the operating instructions for the controller.

Manually adjusting the gain

There are two ways to adjust the gain. One way involves using the buttons on the wireless remote control or controller; the other way involves using the Camera menu or Web setup screen [Setup]. The gain can be adjusted more precisely using the Camera menu or Web setup screen [Setup].

For further details, refer to the "Gain" (→page 48, page 77).

<NOTE>

- When adjusting the gain, the light quantity may change suddenly (causing the image output to be subjected to a shock).

When performing operations from a wireless remote control

1. Press one of the <GAIN> buttons (<OFF>, <LOW> or <HI>).
These buttons enable the gain increase to be selected in three steps. The <LOW> button is used to select 9 dB; the <HI> button is used to select 18 dB.
2. If necessary, press the [AUTO] button of <Gain> in order to return the gain to the automatic adjustment (AGC).

When performing operations from a controller

When using an AW-RP50, AW-RP120, or AK-HRP200

Refer to the operating instructions for the controller.

In any case, the maximum gain of the automatic adjustment (AGC) can be set by the camera menu or Web setup screen [Setup].

For further details, refer to the "AGC Max Gain" (→page 48, page 77).

Preset memories

This unit enables up to 100 settings for the camera direction (panning and tilting), zoom, focus, iris, gain and white balance to be registered in its preset memories, and called.

However, the number of settings that can be registered and called depends on the type of wireless remote control or controller that is used for operation.

- The focus and iris operating modes (manual and auto settings) are neither registered nor recalled. The current focus and iris values are registered.
- The focus and iris values can be recalled only when the manual settings are applicable.
- For the white balance, the current White Balance Mode adjustment values are registered. If a preset value is recalled when AWB A or AWB B is selected, the adjustment value selected when it was registered as a preset will be recalled. The R Gain and B Gain values return to 0 in such cases.

<NOTE>

- When there is a large difference in the environmental temperature between the time of registration and the time the setting is called, displacement of the preset position may occur.
- If displacement occurs, perform registration again.
- When a manual operation is performed for pan, tilt, zoom, focus or iris during preset recall, the preset operation for the pan, tilt, zoom, focus or iris operation concerned will be aborted.
- If another preset has been recalled during an ongoing preset recall, the preset being recalled is aborted, and operation for the preset called last is performed instead.

When performing operations from a wireless remote control

Twelve settings (preset No.1 to No.12) can be registered and called using the wireless remote control.

The <1> to <12> buttons correspond to the unit's preset memories No.1 to No.12.

■ Registering the settings in the preset memories

1. Display the picture to be shot on the monitor.

Operate the pan, tilt or zoom buttons to determine the camera angle. Adjust the focus, iris, gain and white balance if they need to be adjusted.

2. While holding down the <PRESET> button, press the button corresponding to the preset memory number.

- If a preset memory number with an already registered setting has been selected, the existing setting will be erased and replaced with the new one.

■ Calling the settings of the preset memories

1. Press the button in which the preset memory setting has been registered.

When performing operations from a controller

When using an AW-RP50 or AW-RP120

Up to 100 entries can be registered/recalled.

For details, refer to the operating instructions for the controller.

When using an AK-HRP200

Preset memories cannot be registered or recalled.

White balance adjustment

Adjust the ratio between the three primary colors (RGB) to reproduce white accurately. If the white balance is out of adjustment, not only will white be reproduced poorly, but the color tones of the screen as a whole will also be degraded.

- Perform adjustment when using the unit for the first time or when the unit has not been used for a prolonged period.
- Perform adjustment when the lighting conditions or brightness changes.

Either AWB (automatic white balance adjustment) which initiates automatic adjustment when the <AWB> button on the controller has been pressed or ATW (automatic tracking white balance adjustment) which constantly adjusts the white balance can be selected for adjustment purposes.

The results of the AWB adjustment can be stored in two memories, A and B, when [AWB A] or [AWB B] has been selected for the white balance.

- Once the white balance values have been adjusted, their setup procedure will be completed simply by selecting them using the camera menus or Web setup screen [Setup], or by pressing the buttons on the controller, provided that they are going to be used under the same conditions as the ones established when the values were set. There is no need to set it again.
- Once a new setting is entered, the previous setting will be erased.
- White balance adjustment is not possible in night mode.

Use the two memories to store settings corresponding to different shooting conditions.

Automatic adjustment (AWB: AWB A or AWB B)

When performing operations from a wireless remote control

1. Shoot a white subject (such as a white wall or handkerchief) so that it fills the screen.
 - Do not shoot shiny or very bright objects.
- Steps 2 through 8 represent the procedure for selecting the [AWB A] or [AWB B] memory. They need not be taken if a selection has already been made.
2. Select [Scene1], [Scene2], [Scene3] or [Scene4] as the shooting mode by following the procedure in “Selecting the shooting modes (scene files)” (→ page 27).

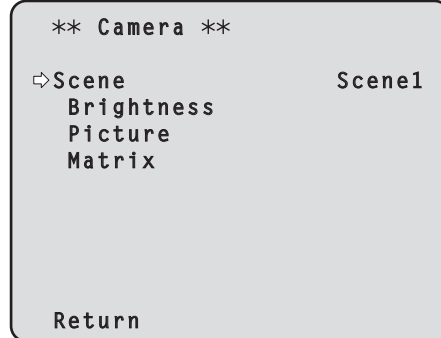

3. Press the <▲> or <▼> button to bring the cursor to [Picture].

4. Press the <○> button.

The [Picture 1/3] sub-menu is displayed.

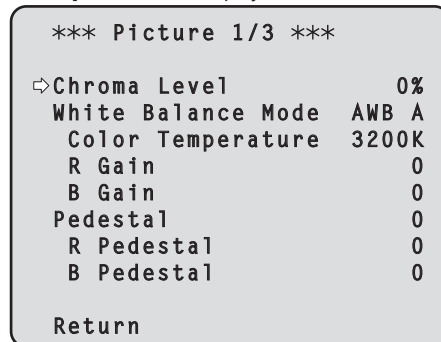

5. Press the <▲> or <▼> button to bring the cursor to [White Balance Mode].

6. Press the <○> button.

[White Balance Mode] starts blinking.

7. Press the <▲> or <▼> button to change the White Balance Mode to be used to [AWB A] or [AWB B], and press the <○> button to enter the selection.

8. Press and hold the <MENU> button for about 2 seconds.

The camera menu display is exited.

White balance adjustment (continued)

9. Press the <SET> button for 2 seconds.

The auto white balance adjustment (AWB) and auto black balance adjustment (ABB) are performed, and the white balance setting is entered.

- When [On] has been selected as the [OSD Status] (→ page 57) setting, the “AWB OK” message will appear at the center of the screen when the white balance adjustment is completed successfully.

When the black balance adjustment is completed successfully, the “ABB OK” message appears at the center of the screen.



<NOTE>

- The black balance is set at the same time.
When this takes place, the lens is closed and then the adjustment is performed so the screen will temporarily turn black.
When only the auto white balance adjustment (AWB) is to be performed, ensure that the <SET> button is pressed or held down for a period of time which does not exceed 2 seconds.
- Adjustment cannot be performed while the color bar is displayed.
Switch to the camera image by pressing the <MODE> button.
- When the adjustment has failed, an error message such as “OUT RANGE NG”, “HIGH LIGHT NG”, “LOW LIGHT NG” or “ATW NG” is displayed.

When performing operations from a controller

When using an AW-RP50, AW-RP120, or AK-HRP200

Refer to the operating instructions for the controller.

<NOTE>

- White balance may not be correctly set if the lighting of the object is too weak.
- Since the unit has a built-in memory, the set white balance will remain in the memory even if power is turned off. Therefore, it is not necessary to reset the white balance if the color temperature of those objects remains unchanged. However, it must be reset if the color temperature changes, such as when you move from indoors to outside, or vice versa.

Auto tracking white adjustment (ATW)

When the white balance adjustment is set to [ATW], the white balance continues to be adjusted automatically all the time, and it is automatically corrected even when the light source or color temperature has changed to produce completely natural pictures.

This function works when [ATW] is selected instead of [AWB A] or [AWB B] by following the steps for “Automatic adjustment” in “White balance adjustment” (→ page 32).

<NOTE>

- ATW might not function properly when high brightness light (ex. fluorescent lamp) beams into a screen.
- White balance may not be accurately set if there is no white object in the scene being shot.
- The white balance may shift out of adjustment when different kinds of light sources such as sunlight and fluorescent lighting are applied.

3200K and 5600K presets

When [3200K] or [5600K] is selected for the white balance, the white balance is set using a color temperature of 3200 K (equivalent to halogen light) or 5600 K (equivalent to daylight), respectively. This function works when [3200K] or [5600K] is selected instead of [AWB A] or [AWB B] by following the steps for “Automatic adjustment” in “White balance adjustment” (→ page 32).

(From the controller, this operation can be performed only using the menu displays. Refer to “Basic setup operations” (→ page 37).)

VAR

When [VAR] is selected for the white balance, you can select a color temperature between 2000 K and 15000 K.

<NOTE>

- The displayed [VAR] value does not guarantee an absolute value. Use the value as a reference.

Black balance adjustment

Adjust the zero levels of the three primary colors (RGB) to reproduce black accurately. If the black balance is out of adjustment, not only will black be reproduced poorly, but the color tones of the screen as a whole will also be degraded.

Readjustment of the black balance is not required under normal circumstances but is necessary in the following situations.

- **Perform adjustment when using the unit for the first time or when the unit has not been used for a prolonged period.**
- **Perform adjustment when the ambient temperature changes significantly, such as during changes of the season.**

Automatic adjustment

When performing operations from a wireless remote control

The procedure is identical to that of "Automatic adjustment" (→ page 32) in "White balance adjustment".

The black balance can be configured by performing automatic white balance adjustment (AWB) and automatic black balance adjustment (ABB).

- The white balance will also be configured, so be sure to prepare the conditions for white balance adjustment before performing the procedure.
- Adjustment cannot be performed while the color bar is displayed. Switch to the camera image by pressing the <MODE> button.

When performing operations from a controller

When using an AW-RP50, AW-RP120, or AK-HRP200

Refer to the operating instructions for the controller.

Black level (master pedestal) adjustment

The black level can be adjusted when using a multiple number of cameras including the unit. Ask your dealer to perform this adjustment. (Use an oscilloscope or waveform monitor for the adjustment.)
Adjust the black level in accordance with the units and devices used.

When performing operations from a controller

When using an AW-RP50, AW-RP120, or AK-HRP200
Refer to the operating instructions for the controller.

When performing operations from a wireless remote control

1. Press the <M/IRIS> button.

Set the iris to the manual mode.

2. Press the <IRIS →> button.

The lens iris is stopped down.

3. Press the <▲> or <▼> button to bring the cursor to [Picture].

4. Press the <○> button.

The [Picture 1/3] sub-menu is displayed.

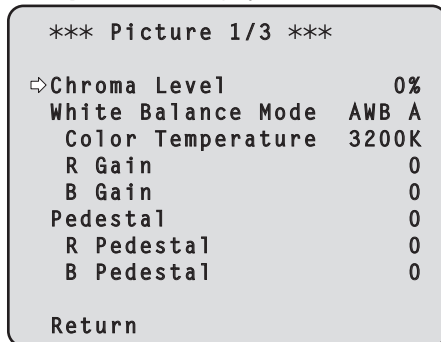

5. Press the <▲> or <▼> button to bring the cursor to [Pedestal].

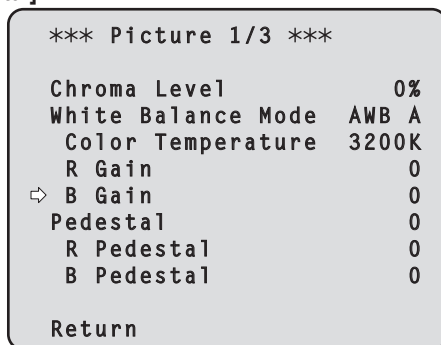

6. Press the <○> button to start the [Pedestal] value blinking.

7. Press the <▲> or <▼> button, change the [Pedestal] value, and press the <○> button to enter the selection.

Adjust the value so that it matches the black level.



The pedestal values can be adjusted finely using the [R Pedestal] and [B Pedestal] settings. (→ page 49, page 79)

8. Press and hold the <MENU> button for about 2 seconds.

The camera menu display is exited.

9. If necessary, press the <A/IRIS> button to adjust the iris automatically.

Genlock adjustment

The genlock adjustment is performed to achieve phase alignment by applying external synchronization (genlock) when a multiple number of cameras will be used or when the unit will be used in combination with other devices.

This unit supports BBS (Black Burst Sync) and tri-level sync external synchronization signals.

Ask your dealer to perform this adjustment.

(Use a dual-trace oscilloscope for the adjustment.)

Horizontal phase adjustment

Observe the waveforms of the external sync signal input (tri-level sync signal) and video signal output on the dual-trace oscilloscope, and use the wireless remote control or controller to bring the horizontal phase into alignment.

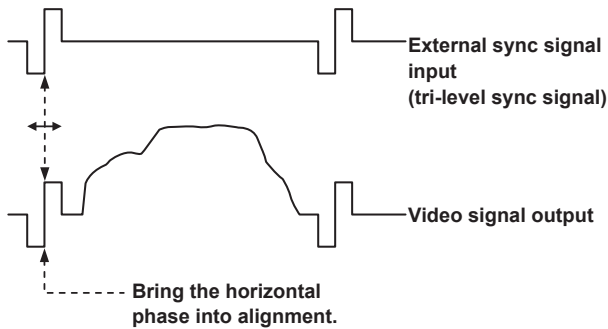

Example: When the tri-level sync phase is adjusted

When performing operations from a wireless remote control

1. Follow the operation steps in “Basic setup operations” (→ page 37) to display the Top Menu.
2. Press the <▲> or <▼> button to bring the cursor to [System].

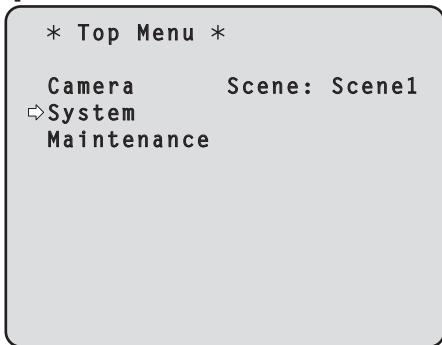

3. Press the <○> button. The [System] screen appears.

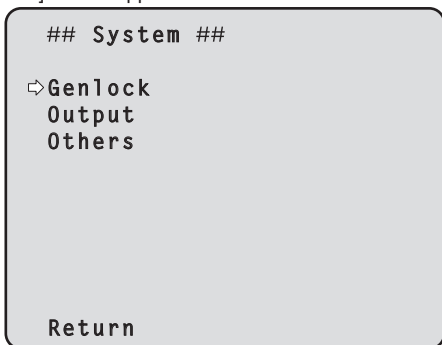

4. Press the <▲> or <▼> button to bring the cursor to [Genlock], and press the <○> button.

The [Genlock] sub-menu is displayed.

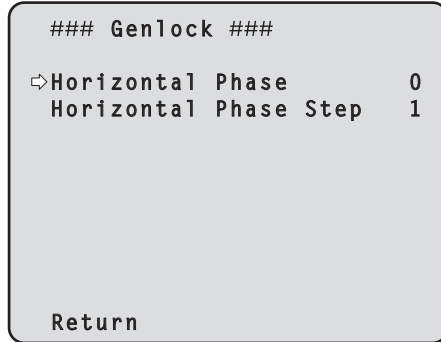

5. Press the <▲> or <▼> button to bring the cursor to [Horizontal Phase], and press the <○> button.

The [Horizontal Phase] value starts blinking.

6. Press the <▲> or <▼> button to change the [Horizontal Phase] value, adjust the value so that the horizontal phase is brought into alignment, and press the <○> button.

The extent of the phase adjustment can be selected using [Horizontal Phase Step].

7. Press and hold the <MENU> button for about 2 seconds.

The camera menu display is exited.

When performing operations from a controller

These operations can be performed using the camera menus by following the operation steps in “Basic setup operations” (→pages 37 to 45).

Basic setup operations

Camera menus are displayed on the monitor when the unit's settings are to be selected.

The monitor is connected to the video signal output connector. The basic camera menu operations involve displaying sub-menus from the Top Menu items, and selecting settings on the sub-menus. Some sub-menus have menu items for performing more detailed settings.

The camera menu operations are conducted using the wireless remote control.

If a controller is connected, they can also be conducted using the controller.

<NOTE>

- Check that your controller is the following version.

AW-RP50: Ver 3.00.00 or later

AW-RP120: Ver 2.00.00 or later

AK-HRP200: Ver 4.00-00-0.00 or later

If the version older, an upgrade is required.

For details on upgrading, visit the support page on the following website.

<https://pro-av.panasonic.net/>

Described below are the Basic setup operations for changing the camera menu item settings using the wireless remote control and controller (AW-RP50, AW-RP120 or AW-HRP200).

Only the steps taken using the wireless remote control will be described here for the operations conducted to select and set the items.

For details of the operations conducted using the controller, substitute "controller" for "wireless remote control" when reading the Basic setup operations.

Refer to the operating instructions for the controller.

Wireless remote control and controller operations

Camera menu operation	Wireless remote control	Controller		
		AW-RP50	AW-RP120	AK-HRP200
Selecting a camera to operate	Press the <CAM1>, <CAM2>, <CAM3>, or <CAM4> button.	Press the <CAMERA STATUS> or <SELECTION> button.		<ol style="list-style-type: none"> 1. Press and hold the <SELECT> button for about 2 seconds. → The camera number in the camera number display area blinks. 2. Press the lit <UP> and <DOWN> button. → Press the lit <UP> and <DOWN> buttons to select the camera number. 3. Press the <SELECT> button. → Control of the selected camera is enabled.
Displaying the Top Menu	Press and hold the <MENU> button for about 2 seconds.	Press and hold the <CAMERA OSD> button for about 2 seconds.		Press and hold the <CHARA/MENU> button for about 2 seconds.
Selecting items	Press the <▲>, <▼>, <◀>, or <▶> button.	Turn the <F1> dial.		Turn the <SELECT> dial.
Displaying sub-menus	Press the <○> button.	Press the <F1> dial.		Press the <SELECT> dial.
Returning to the previous menu	Place the cursor on [Return], and press the <○> button.	Place the cursor on [Return], and press the <F1> dial.		Place the cursor on [Return], and press the <SELECT> dial.
Changing settings	Place the cursor on the item you want to change, and press the <○> button to make the setting value blink. Change the value using the <▲>, <▼>, <◀>, or <▶> button, and press the <○> button to confirm.	<ol style="list-style-type: none"> 1. Press the <F1> dial to make the setting value blink. 2. Turn the <F1> dial to change the setting value. 3. Press the <F1> dial to confirm the setting value (blinking stops). 		<ol style="list-style-type: none"> 1. Press the <SELECT> dial to make the setting value blink. 2. Turn the <SELECT> dial to change the setting value. 3. Press the <SELECT> dial to confirm the setting value (blinking stops).
Canceling setting changes	Tap the <MENU> button (hold for less than 2 seconds) while the setting value is blinking.	—		—
Exiting camera menu operations	Press and hold the <MENU> button for about 2 seconds.	Press and hold the <CAMERA OSD> button for about 2 seconds.		Press and hold the <CHARA/MENU> button for about 2 seconds.

<NOTE>

- Perform the menu operations and exit from the menus using the controller which displayed the Top Menu. If a menu operation has been performed or a menu has been exited using another controller, first display the Top Menu and exit from it using one controller, and then display the Top Menu and exit from it using the other controller.
- The procedures used for this unit's menu operations may differ from the ones used for the convertible cameras and HD integrated cameras which have already been released on the market. For details, refer to the Operating Instructions of the camera concerned.
- The response speed of the camera differs slightly depending on the controller used.

When performing the operations using the wireless remote control

- 1. Press the <CAM1>, <CAM2>, <CAM3> or <CAM4> button to select the unit which is to be operated.**
- 2. Press and hold the <MENU> button for about 2 seconds.**
The Top Menu is displayed.
- 3. Press the <▲> or <▼> button to bring the cursor to the item to be selected.**
Each time the <▲> or <▼> button is pressed, the cursor moves.
The cursor can be moved in the same way using the <◀> or <▶> buttons.
- 4. Press the <○> button.**
The sub-menu of the selected item is displayed.
(Some sub-menu items have a sub-menu of their own.)
- 5. Press the <▲> or <▼> button to bring the cursor to the item to be set.**
Each time the <▲> or <▼> button is pressed, the cursor moves.
The cursor can be moved in the same way using the <◀> or <▶> button.
With the cursor at the "Return" position, press the <○> button to return to the previous menu.
- 6. Press the <○> button.**
The value of the item to be set starts blinking.
- 7. Press the <▲> or <▼> button to change the setting.**
The setting can be changed in the same way using the <◀> or <▶> button.
- 8. Press the <○> button.**
The value of the item to be set is entered, and it stops blinking.
- 9. After the setting has been completed, press the <MENU> button for 2 seconds.**
The camera menu display is exited.

Operations on the AW-RP50 Remote Camera Controller

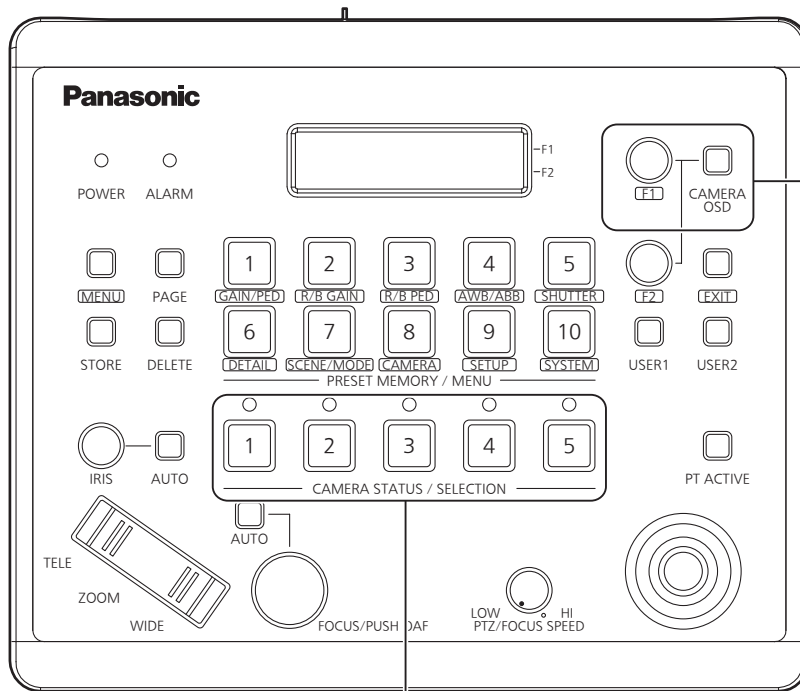

Selects a camera to be operated.

For operating the camera menus.
CAMERA OSD:
 When this is pressed for 2 seconds, the selected camera menu is displayed, overlapping the camera output image. When it is pressed for 2 seconds while a camera menu is displayed, the menu is exited.
F1: Turn to move the cursor up and down in the camera menu or to change setting values. Press to move to the next level of a menu item or to change a setting value at the lowest level.

■ Camera menu operation

1. Press the appropriate <CAMERA STATUS/SELECTION> button to select the unit you want to operate.
2. Press and hold the <CAMERA OSD> button on the AW-RP50 for about 2 seconds.
The AW-HE130 camera menu appears on the monitor.
3. Turn the <F1> dial to select an AW-HE130 camera menu item or to change a setting value.
Turn the <F1> dial to move the cursor up and down or to change setting values.
Press the <F1> dial to move to the next level of a menu item or to change a setting value at the lowest level.
4. To exit the camera menu, press and hold the <CAMERA OSD> for about 2 seconds.

■ Switching between day and night mode

1. Press the <MENU> button on the AW-RP50.
The <MENU> button lights, and the <PRESET MEMORY/MENU> buttons become selectable.
2. Press the <9 (SETUP)> button in the <PRESET MEMORY/MENU> area.
The button lights, and the [SETUP] menu appears on the LCD panel.
3. Turn the <F1> dial to select [FUNCTION], then press the <F1> dial.
4. Turn the <F1> dial to select [OPTION].
[Off] or [On] appears on the bottom right (F2 area) of the LCD panel.
5. Turn the <F2> dial to select [Off] or [On], then press the <F2> dial.
Off: Day mode
On: Night mode

■ Color temperature setting (COLOR TEMP)

1. Press the <MENU> button on the AW-RP50.
The <MENU> button lights, and the <PRESET MEMORY/MENU> buttons become selectable.
2. Press the <4 (AWB/ABB)> button in the <PRESET MEMORY/MENU> area.
The button lights, and the [AWB/ABB] menu appears on the LCD panel.
3. Turn the <F1> dial to select [VAR].
Color temperature configuration is enabled when [VAR] is selected, and it is initially set to the color temperature held on the camera. To adjust the setting, proceed to the following.
4. Press the <8 (CAMERA)> button in the <PRESET MEMORY/MENU> area.
The button lights, and the [GROUP] menu appears on the LCD panel.
5. Turn the <F1> dial to select [COLOR TEMP], then press the <F1> dial.
The color temperature appears on the bottom right (F2 area) of the LCD panel.
6. Turn the <F2> dial to select the color temperature, then press the <F2> dial.

■ Preset speed table setting (PRESET SPEED)

- 1. Press the <MENU> button on the AW-RP50.**
The <MENU> button lights, and the <PRESET MEMORY/MENU> buttons become selectable.
- 2. Press the <9 (SETUP)> button in the <PRESET MEMORY/MENU> area.**
The button lights, and the [USER] menu appears on the LCD panel.
- 3. Turn the <F1> dial to select [PRESET], then press the <F1> dial.**
- 4. Turn the <F1> dial to select [PRESET SPEED], then press the <F1> dial.**
[Slow] or [Fast] appears on the bottom right (F2 area) of the LCD panel.
- 5. Turn the <F2> dial to select [Slow] or [Fast], then press the <F2> dial.**

■ Freezing images during preset playback (FREEZE DURING)

- 1. Press the <MENU> button on the AW-RP50.**
The <MENU> button lights, and the <PRESET MEMORY/MENU> buttons become selectable.
- 2. Press the <9 (SETUP)> button in the <PRESET MEMORY/MENU> area.**
The button lights, and the [USER] menu appears on the LCD panel.
- 3. Turn the <F1> dial to select [FUNCTION], then press the <F1> dial.**
- 4. Turn the <F1> dial to select [FREEZE DURING], then press the <F1> dial.**
[Off] or [On] appears on the bottom right (F2 area) of the LCD panel.
- 5. Turn the <F2> dial to select [Off] or [On], then press the <F2> dial.**
Off: Do not freeze the current preset playback images.
On: Freeze the current preset playback images.

■ Optical image stabilization (OIS) function settings

- 1. Press the <MENU> button on the AW-RP50.**
The <MENU> button lights, and the <PRESET MEMORY/MENU> buttons become selectable.
- 2. Press the <9 (SETUP)> button in the <PRESET MEMORY/MENU> area.**
The button lights, and the [USER] menu appears on the LCD panel.
- 3. Turn the <F1> dial to select [FUNCTION], then press the <F1> dial.**
- 4. Turn the <F1> dial to select [I.S.], then press the <F1> dial.**
[Off] or [On] appears on the bottom right (F2 area) of the LCD panel.
- 5. Turn the <F2> dial to select [Off] or [On], then press the <F2> dial.**
Off: Turn the optical image stabilization function off.
On: Turn the optical image stabilization function on.

■ Digital extender setting (D.EXTENDER)

- 1. Press the <MENU> button on the AW-RP50.**
The <MENU> button lights, and the <PRESET MEMORY/MENU> buttons become selectable.
- 2. Press the <9 (SETUP)> button in the <PRESET MEMORY/MENU> area.**
The button lights, and the [USER] menu appears on the LCD panel.
- 3. Turn the <F1> dial to select [FUNCTION], then press the <F1> dial.**
- 4. Turn the <F1> dial to select [D.EXTENDER], then press the <F1> dial.**
[Off] or [On] appears on the bottom right (F2 area) of the LCD panel.
- 5. Turn the <F2> dial to select [Off] or [On], then press the <F2> dial.**
Off: Turn the digital extender function off.
On: Turn the digital extender function on.

■ Assigning “FREEZE DURING”, “COLOR TEMP”, and “D.EXT” to the <USER> buttons

You can assign the on/off functions for freezing images during preset playback (FREEZE DURING), color temperature settings (COLOR TEMP), and the digital extender function (D.EXT) to the <USER> buttons.

- 1. Press the <MENU> button on the AW-RP50.**
The <MENU> button lights, and the <PRESET MEMORY/MENU> buttons become selectable.
- 2. Press the <9 (SETUP)> button in the <PRESET MEMORY/MENU> area.**
The button lights, and the [USER] menu appears on the LCD panel.
- 3. Turn the <F1> dial to select [USER1] or [USER2], then press the <F1> dial.**
The functions that can be assigned to the <USER> button appear on the bottom right (F2 area) of the LCD panel.
- 4. Turn the <F2> dial to select “FREEZE DURING”, “COLOR TEMP”, or “D.EXT”, then press the <F2> dial.**
FREEZE DURING: Function that freezes the current preset playback images.
COLOR TEMP: Color temperature settings
D.EXT: Digital extender function

Operations on the AW-RP120 Remote Camera Controller

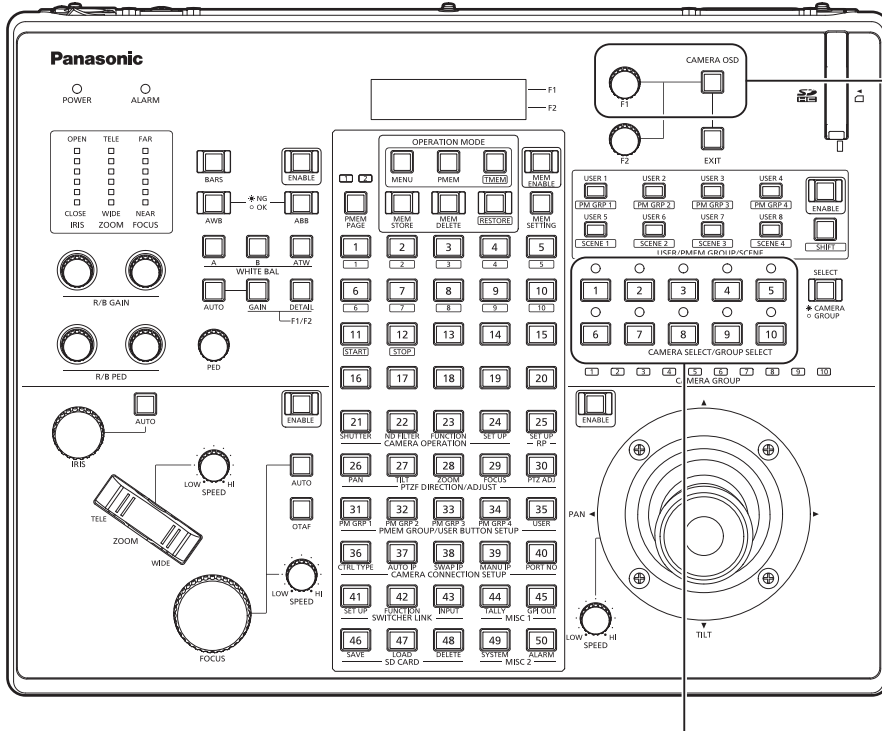

For operating the camera menus.
CAMERA OSD:
 When this is pressed for 2 seconds, the selected camera menu is displayed, overlapping the camera output image. When it is pressed for 2 seconds while a camera menu is displayed, the menu is exited.
F1: Turn to move the cursor up and down in the camera menu or to change setting values. Press to move to the next level of a menu item or to change a setting value at the lowest level.

Selects a camera to be operated.

■ Camera menu operation

1. Press the appropriate <CAMERA SELECT/GROUP SELECT> button (<1> to <10>) to select the unit you want to operate.
2. Press and hold the <CAMERA OSD> button on the AW-RP120 for about 2 seconds.
The AW-HE130 camera menu appears on the monitor.
3. Turn the <F1> dial to select an AW-HE130 camera menu item or to change a setting value.
Turn the <F1> dial to move the cursor up and down or to change setting values.
Press the <F1> dial to move to the next level of a menu item or to change a setting value at the lowest level.
4. To exit the camera menu, press and hold the <CAMERA OSD> button for about 2 seconds.

■ Switching between day and night mode

1. Press the <MENU> button on the AW-RP120.
The <MENU> button lights.
2. Press the FUNCTION menu <23> button.
The button lights, and the [OPTION] menu appears on the LCD panel.
3. Turn the <F1> dial to select [FUNCTION], then press the <F1> dial.
4. Turn the <F1> dial to select [OPTION].
[Off] or [On] appears on the bottom right (F2 area) of the LCD panel.
5. Turn the <F2> dial to select [Off] or [On], then press the <F2> dial.
Off: Day mode
On: Night mode

■ Color temperature setting (COLOR TEMP)

1. Press the <EXIT> button and the <ATW> button of <WHITE BAL> simultaneously.
The <A>, , <ATW> buttons of <WHITE BAL> light, and color temperature setting mode is enabled.
The color temperature setting value appears on the LCD screen during this time.
2. Turn the <F1> dial to change the color temperature.
Press the <A>, , and <ATW> buttons of <WHITE BAL> to return to the mode of the selected button.
The mode will switch from the color temperature mode to the original mode after a specific amount of time passes. To configure the color temperature setting again, press the <EXIT> button and the <ATW> button of <WHITE BAL> simultaneously.

■ Preset speed table setting (PRESET SPEED)

1. Press the <MENU> button on the AW-RP120.
The <MENU> button lights.
2. Press the FUNCTION menu <23> button.
The button lights, and the [OPTION] menu appears on the LCD panel.
3. Turn the <F1> dial to select [PRESET SPEED], then press the <F1> dial.
[Slow] or [Fast] appears on the bottom right (F2 area) of the LCD panel.
4. Turn the <F2> dial to select [Slow] or [Fast], then press the <F2> dial.

■ Freezing images during preset playback (FREEZE DURING)

- 1. Press the <MENU> button on the AW-RP120.**
The <MENU> button lights.
- 2. Press the FUNCTION menu <23> button.**
The button lights, and the [OPTION] menu appears on the LCD panel.
- 3. Turn the <F1> dial to select [FREEZE DURING], then press the <F1> dial.**
[Off] or [On] appears on the bottom right (F2 area) of the LCD panel.
- 4. Turn the <F2> dial to select [Off] or [On], then press the <F2> dial.**
Off: Do not freeze the current preset playback images.
On: Freeze the current preset playback images.

■ Optical image stabilization (OIS) function settings

- 1. Press the <MENU> button on the AW-RP120.**
The <MENU> button lights.
- 2. Press the FUNCTION menu <23> button.**
The [OPTION] menu appears on the LCD panel.
- 3. Turn the <F1> dial to select [I.S.], then press the <F1> dial.**
[Off] or [On] appears on the bottom right (F2 area) of the LCD panel.
- 4. Turn the <F2> dial to select [Off] or [On], then press the <F2> dial.**
Off: Turn the optical image stabilization function off.
On: Turn the optical image stabilization function on.

■ Digital extender settings (D.EXTENDER)

- 1. Press the <MENU> button on the AW-RP120.**
The <MENU> button lights.
- 2. Press the FUNCTION menu <23> button.**
The [OPTION] menu appears on the LCD panel.
- 3. Turn the <F1> dial to select [D.EXTENDER], then press the <F1> dial.**
[Off] or [On] appears on the bottom right (F2 area) of the LCD panel.
- 4. Turn the <F2> dial to select [Off] or [On], then press the <F2> dial.**
Off: Turn the digital extender function off.
On: Turn the digital extender function on.

■ Assigning “FREEZE DURING”, “COLOR TEMP”, and “D.EXT” to the <USER> buttons

You can assign the on/off functions for freezing images during preset playback (FREEZE DURING), color temperature settings (COLOR TEMP), and the digital extender function (D.EXT) to the <USER> buttons.

- 1. Press the <MENU> button on the AW-RP120.**
The <MENU> button lights.
- 2. Press the USER menu <35> button.**
The button lights, and the [USER1] menu appears on the LCD panel.
- 3. Turn the <F1> dial to select [USER1] to [USER8], then press the <F1> dial.**
The functions that can be assigned to the <USER> button appear on the bottom right (F2 area) of the LCD panel.
- 4. Turn the <F2> dial to select [FREEZE DURING], [COLOR TEMP] or [D.EXT], then press the <F2> dial.**
FREEZE DURING: Function that freezes the current preset playback images
COLOR TEMP: Color temperature settings
D.EXT: Digital extender function

<NOTE>

- The [FOCUS] indicator may not appear correctly in some cases.

Operations on the AK-HRP200 Remote Operation Panel

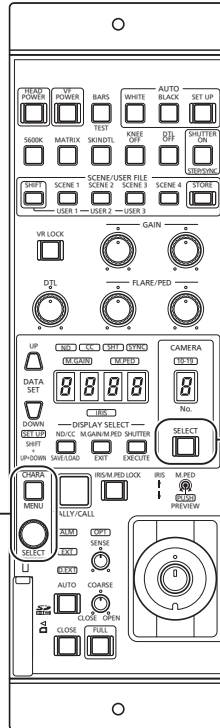

For operating the camera menus.
 When the <CHARA/MENU> button is pressed for 2 seconds, the selected camera menu is displayed, overlapping the camera output image. When it is pressed for 2 seconds while a camera menu is displayed, the menu is exited.
SELECT:
 Turn to move the cursor up and down in the camera menu or to change setting values. Press to move to the next level of a menu item or to change a setting value at the lowest level.

Selects a camera to be operated.

1. Press <SELECT> for about 2 seconds.
 The camera number in the camera number display area blinks.
2. Press the lit <DATA SET> buttons (<UP> and <DOWN>).
 Press the lit <DATA SET> buttons (<UP> and <DOWN>) to select the camera number.
3. Press the <SELECT> (camera selection) button.
 Control of the selected camera is enabled.

■ Camera menu operation

1. Press and hold the <CHARA/MENU> button on the AK-HRP200 for about 2 seconds.

The AW-HE130 camera menu appears on the monitor.

2. Turn the <SELECT> dial to select an AW-HE130 camera menu item or to change a setting value.

Turn the <SELECT> dial to move the cursor up and down or to change setting values.

Press the <SELECT> dial to move to the next level of a menu item or to change a setting value at the lowest level.

3. To exit the camera menu, press and hold the <CHARA/MENU> button for about 2 seconds.

Basic setup operations (continued)

The following operations can be performed from the AK-HRP200 Remote Operation Panel.
For details on operations, refer to the AK-HRP200 Operating Instructions <Basics>.

	Control/display component	Label	AW-HE130	Remarks
1	Camera power switch	HEAD POWER	Supported	
2	VF power switch	VF POWER	—	
3	Color bar signal output switch	BARS/TEST	Supported with some restrictions	Does not transit to TEST_ON.
4	Auto white balance switch	AUTO WHITE	Supported	Running state after accepting AWB/ABB lasts at least 2 sec.
5	Auto black balance switch	AUTO BLACK	Supported	Running state after accepting AWB/ABB lasts at least 2 sec.
6	Auto setup switch	AUTO SETUP	—	
7	5600 k switch	5600k	—	
8	Matrix switch	MATRIX	—	
9	Skin color detail switch	SKIN DTL ON	—	
10	Knee OFF switch	KNEE OFF	—	
11	Detail OFF switch	DTL OFF	Supported	
12	Shutter ON/OFF switch, STEP/SYNC switch	SHUTTER ON STEP/SYNC	Supported with some restrictions	The shutter value is fixed during transition from SYNC (see No. 36).
13	Scene / user file selection switch	SCENE/USER FILE SHIFT	—	
14	Scene / user file 1 switch	SCENE/USER FILE1	Supported	
15	Scene / user file 2 switch	SCENE/USER FILE2	Supported	
16	Scene / user file 3 switch	SCENE/USER FILE3	Supported	
17	Scene file 4 switch	SCENE FILE 4	Supported	
18	Scene / user file storage switch	SCENE/USER FILE STORE	—	
19	Volume lock switch	VOL LOCK	Supported	
20	R gain volume	GAIN R	Supported	
21	B gain volume	GAIN B	Supported	
22	R flare / pedestal volume	FLARE/PED	PED: Supported	
			FLR: —	
23	B flare / pedestal volume	FLARE/PED	PED: Supported	
			FLR: —	
24	DTL volume	DTL	—	
25	Data set (up)	DATA SET UP	Supported	
26	Data set (down)	DATA SET DOWN	Supported	
27	Adjustment value display	None	Supported	
28	IRIS display	IRIS	Supported with some restrictions	Operation is supported, but the IRIS value cannot be displayed.
29	ND/CC display selection switch	DISPLAY SELECT	Supported with some restrictions	Used for ZOOM / FOCUS MODE switching.
		ND/CC		Used for ND / ZOOM / FOCUS MODE switching.
30	ND display	ND	Supported	
31	CC display	CC	—	
32	M.GAIN / M.PED display	DISPLAY SELECT	Supported	
	Selection switch	M.GAIN/M.PED		
33	M.GAIN display	M.GAIN	Supported	
34	M.PED display	M.PED	Supported	
35	SHUTTER display selection	DISPLAY SELECT	Supported	
	Switch	SHUTTER		
36	SHUTTER display	SHT	Supported with some restrictions	The shutter value is fixed during transition from SYNC. <ul style="list-style-type: none"> • For 59.94p, 59.94i: 1/100 • For 29.97p: 1/120 • For 23.98p: 1/120 • For 50p, 50i: 1/120 • For 25p: 1/120
37	SYNC display	SYNC	Supported with some restrictions	The display for 7SEG will be "----" during SYNC.
38	Camera number display	CAM No.	Supported	
39	Camera number tens display	10-19	Supported	
40	Camera selection switch	CAM SEL	Supported	
41	Menu / character switch	CHARA MENU ON/OFF	Supported	

Basic setup operations (continued)

	Control/display component	Label	AW-HE130	Remarks
42	Rotary selection switch	SELECT	Supported	Only enabled during MENU ON. When ZOOM is selected, FOCUS adjustment is possible on the selection dial. When FOCUS is selected, ZOOM adjustment is possible on the selection dial.
43	Red/green tally display, call switch	TALLY/CALL	Supported with some restrictions	CALL is disabled.
44	Alarm display	ALARM	—	
45	Optical alarm display	OPT	—	
46	Iris / master pedestal lock	IRIS/M.PED LOCK	Supported	
47	Iris lever	IRIS (↑↓)	Supported with some restrictions	The IRIS value cannot be displayed for 7SEG.
48	Master pedestal volume	M.PED (← →)	Supported	
49	Preview switch	PUSH PREVIEW	—	
50	Fader full switch	FADER FULL	—	
51	Auto iris switch	AUTO	Supported	
52	Iris close switch	CLOSE	—	
53	Sense volume	SENSE	Supported with some restrictions	Used for ZOOM/FOCUS SPEED adjustment.
54	Coarse volume	COARSE	—	
55	Lens extender display	EXT	—	
56	Digital extender display	D.EXT	Lights when the digital extender is enabled.	
57	SD card access display	SD CARD	Supported	
63	Zoom		Supported	When ZOOM is selected, FOCUS adjustment is possible on the selection dial.
64	Focus		Supported	When FOCUS is selected, ZOOM adjustment is possible on the selection dial.

Camera menu items

Setting the camera menu items

Camera menus are displayed on the monitor when the unit's settings are to be selected.

The monitor is connected to the video signal output connector.

The basic camera menu operations involve displaying sub-menus from the Top Menu items, and selecting settings on the sub-menus.

Some sub-menus have menu items for performing more detailed settings.

For details on the "Basic setup operations" to display the camera menus and change the items using the wireless remote control or controller (AW-RP50, AW-RP120, AK-HRP200), refer to pages 37 to 45.

The "*" and "#" marks in the menu titles indicate the hierarchical level of the menu currently displayed.

For instance, "* Top Menu *" indicates the first hierarchical level whereas "** Camera **" and "## System ##" indicate that the second hierarchical level is now displayed.

Menu items accompanied by a "*" mark indicate data which is stored on a scene by scene basis; menu items accompanied by a "#" mark indicate data which is stored together for one camera regardless of the scenes.

For details on factory default settings, see "Camera menu item table" (→ page 60).

Top menu (Top Menu) screen

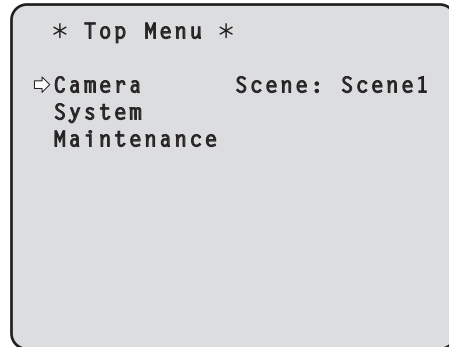

Camera

Select this to open the camera menu relating to the camera images.

System

Select this to display the System menu used to adjust the genlock (external synchronization) phase or establish the camera output image settings.

Maintenance

Select this to display the Maintenance menu used to check the camera's firmware version or initialize its settings.

<NOTE>

- The Top Menu does not have a [Return] setting.
To close the menu screen, use the controller to perform the operation to close the menu screen. For further details, refer to "Basic setup operations" (→pages 37 to 45).

Camera screen

This menu is used for the camera image settings.

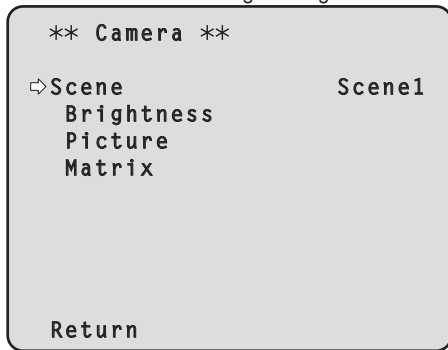

Scene [Scene1, Scene2, Scene3, Scene4]

Selected here is the shooting mode that matches the shooting situation. Select the mode which best suits the prevailing shooting conditions and the user's preferences.

Scene1, Scene2, Scene3, Scene4:

In these modes, the detailed settings and adjustments are established manually to match the prevailing shooting conditions and the user's preferences.

Brightness

This menu item displays the Brightness screen on which to set the brightness of the images.

Two screens (Brightness 1/2, Brightness 2/2) are provided for the brightness adjustment menu.

Picture

This menu item displays the Picture screen on which to adjust the picture quality.

Three screens (Picture 1/3, Picture 2/3 and Picture 3/3) are provided for the picture quality adjustment menu.

Matrix

This menu item displays the Matrix screen on which to set the color matrix.

Five screens (Matrix 1/5, Matrix 2/5, Matrix 3/5 and Matrix 4/5, Matrix 5/5) are provided for the color matrix adjustment menu.

Return

Return to the previous menu level.

Brightness 1/2 screen

This menu item is selected to set the brightness of the pictures.



Picture Level [-50 to +50]

This menu item is selected to set the target picture level for automatic exposure compensation.

Its setting takes effect when [Auto] or [ELC] has been selected as the setting for any of the following automatic exposure compensation functions.

- When [Iris Mode] is set to [Auto]
- When [Shutter Mode] is set to [ELC]
- When [Gain] is set to [Auto]

Iris Mode [Manual, Auto]

This menu item is used to select whether the iris is to be adjusted automatically or manually.

Manual	The iris is adjusted manually.
Auto	Auto exposure compensation is performed so that the target level which was set using [Picture Level] is reached.

<NOTE>

- [Iris Mode] cannot be set to [Auto] when [Frame Mix] is set to [18dB] or [24dB].

Shutter Mode [Off, Step, Synchro, ELC]

Select for camera shutter speed.

Off	The shutter is set to OFF.
Step	The step shutter is set (the steps can be changed).
Synchro	The synchro shutter is set (the setting can be changed continuously).
ELC	The electronic shutter is controlled and the light quantity is adjusted automatically.

Step/Synchro

This is used to adjust the shutter speed in the mode which was selected as the [Shutter Mode] setting.

When a higher shutter speed is selected, fast-moving subjects do not become blurred easily but the images will be darker.

The shutter speeds that can be set are listed below.

When 59.94 Hz has been set as the unit's frequency:

	When [Step] is selected as the [Shutter Mode]	When [Synchro] is selected as the [Shutter Mode]
For 59.94p/59.94i	1/100, 1/120, 1/250, 1/500, 1/1000, 1/2000, 1/4000, 1/10000	60.15Hz to 642.21Hz (255 steps)
For 29.97p	1/30, 1/60, 1/120, 1/250, 1/500, 1/1000, 1/2000, 1/4000, 1/10000	
For 23.98p	1/24, 1/60, 1/120, 1/250, 1/500, 1/1000, 1/2000, 1/4000, 1/10000	

Camera menu items (continued)

When 50 Hz has been set as the unit's frequency:

	When [Step] is selected as the [Shutter Mode]	When [Synchro] is selected as the [Shutter Mode]
For 50p/ 50i	1/60, 1/120, 1/250, 1/500, 1/1000, 1/2000, 1/4000, 1/10000	50.15Hz to 535.71Hz (255 steps)
For 25p	1/25, 1/60, 1/120, 1/250, 1/500, 1/1000, 1/2000, 1/4000, 1/10000	

<NOTE>

- When [Shutter Mode] is set to [Off] in 29.97P, 23.98P, or 25P mode, the shutter speed is set to [1/50].

Gain [Auto, 0dB to 36dB]

The image gain is adjusted here.

In locations which are too dark, adjust the gain upward; conversely, in locations which are too bright, adjust it downward.

When [Auto] is set, the light quantity is adjusted automatically.

The noise increases when the gain is increased.

<NOTE>

- [Gain] cannot be set to [Auto] when [Frame Mix] is set to [18dB] or [24dB].

AGC Max Gain [6dB, 12dB, 18dB]

When [Auto] is selected as the [Gain] setting, the maximum gain-up amount can be set.

Frame Mix [Off, 6dB, 12dB, 18dB, 24dB]

Select for frame addition (gain-up using sensor storage) amount.

When frame addition is performed, it will appear as if the images are missing some frames.

This cannot be configured when the format is 1080/29.97p, 1080/23.98p, 1080/29.97PsF, 1080/23.98PsF, 1080/25p, or 1080/25PsF.

[Frame Mix] cannot be set to [18dB] or [24dB] when [Iris Mode], [Gain], or [Focus Mode] is set to [Auto]. (When setting [Frame Mix] to [18dB] or [24dB], set [Iris Mode] and [Focus Mode] to [Manual] and set [Gain] to any setting other than [Auto].)

<NOTE>

- Under mercury-vapor tube illumination, such as fluorescent and mercury-vapor lights, the brightness may change synchronously, colors may change, and horizontal stripes may flow up and down the image. In such cases, we recommend setting the electronic shutter speed to 1/100 in regions with 50 Hz power supply frequency, and to OFF in regions with 60 Hz power supply frequency.

ND Filter [Through, 1/8, 1/64]

Set the transmittance of the lens' built-in ND (neutral density) filter.

The filter switches when the setting is fixed.

Through	Do not set ND filter.
1/8	Set ND filter transmittance to 1/8.
1/64	Set ND filter transmittance to 1/64.

Return

Return to the previous menu level.

Brightness 2/2 screen

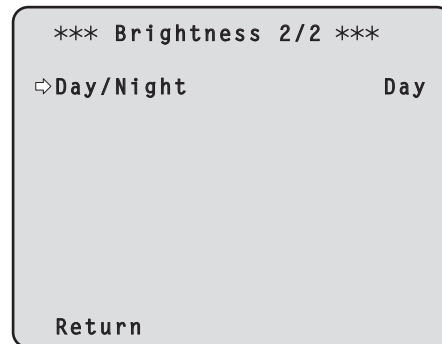

Day/Night [Day, Night]

Switch between standard shooting and night-vision shooting (shooting with infrared light).

Day	Standard shooting (day mode)
Night	Night-vision shooting (night mode)

<NOTE>

- In night mode, video output will be in black and white. In addition, the iris will be forcibly opened.
- White balance adjustment is not possible in night mode.
- ND filter switching is not possible in night mode.
- Pedestal adjustment is not possible in night mode.

Return

Return to the previous menu level.

Picture 1/3 screen

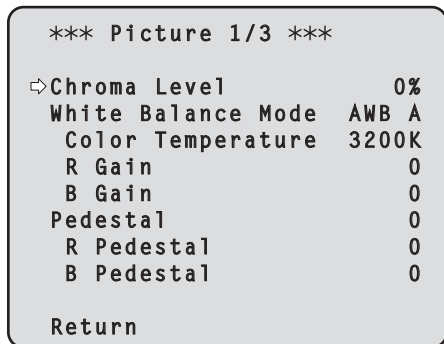

Chroma Level [OFF, -99% to 40%]

Set here the color intensity (chroma level) of the images.

White Balance Mode

[ATW, AWB A, AWB B, 3200K, 5600K, VAR]

Set the white balance mode.

Select the mode when the coloring is not natural because of the nature of the light source or other factors.

If the white color serving as the reference can be recognized, subjects can be shot with natural coloring.

ATW	In this mode, the white balance is compensated for automatically, even if changes occur in the light source or color temperature, by a process of continuous and automatic adjustment.
AWB A AWB B	When [AWB A] or [AWB B] is selected and the white balance is executed, the adjustment results obtained are stored in the memory selected. When [AWB A] or [AWB B] is then selected, the white balance stored in the selected memory can be recalled.
3200K	This is the white balance mode which is ideal when a 3200K halogen light is used as the light source.
5600K	This is the white balance mode which is ideal when 5600K sunlight or fluorescent lighting is used as the light source.
VAR	You can specify a color temperature between 2000 K to 15000 K.

Color Temperature [2000K to 15000K]

You can specify a color temperature between 2000 K to 15000 K. Its setting takes effect when [VAR] has been selected as the [White Balance Mode] setting.

R Gain [-150 to +150]

This enables the R gain to be adjusted. Its setting takes effect when [AWB A], [AWB B] or [VAR] has been selected as the [White Balance Mode] setting.

B Gain [-150 to +150]

This enables the B gain to be adjusted. Its setting takes effect when [AWB A], [AWB B] or [VAR] has been selected as the [White Balance Mode] setting.

Pedestal [-150 to +150]

This item is used to adjust the black level (adjust the pedestal). These parts become darker when a negative setting is selected and, conversely, lighter when a positive setting is selected.

R Pedestal [-100 to +100]

This enables the R pedestal to be adjusted.

B Pedestal [-100 to +100]

This enables the B pedestal to be adjusted.

Return

Return to the previous menu level.

Picture 2/3 screen

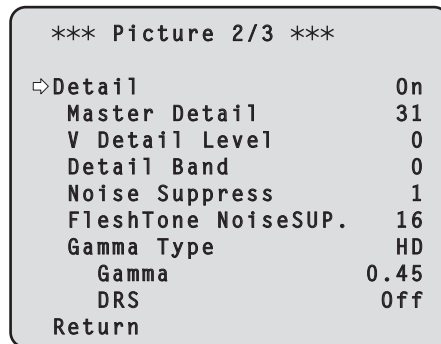

Detail [Off, On]

Turn outline (i.e., image sharpness) adjustment on/off.

Master Detail [0 to 62]

Adjust the contour correction level (master).

V Detail Level [-7 to +7]

Adjust the vertical contour correction level.

Detail Band [-7 to +7]

This is selected to set the boost frequency for Detail.

-7: Low frequency
to
+7: High frequency

When a high frequency is selected, the detail effect is added to subjects with more definition.

Noise Suppress [0 to 60]

This is selected to reduce the screen noise which is generated by the detail effect. The higher the settings, the more the noise is reduced.

FleshTone NoiseSUP. [0 to 31]

This function is selected to make the skin of the subjects to be shot appear to be smoother and more attractive. When "High" is selected, the effect is enhanced.

Gamma Type

[HD, SD, FILMLIKE1, FILMLIKE2, FILMLIKE3]

Select the type of gamma curve.

HD	HD (High Definition) video gamma characteristic.
SD	Gain in dark areas is higher than in HD gamma.
FILMLIKE1	Characteristic capable of reproducing better gradation in highlights than HD gamma.
FILMLIKE2	Characteristic capable of reproducing better gradation in highlights than [FILMLIKE1].
FILMLIKE3	Characteristic capable of reproducing better gradation in highlights than [FILMLIKE2].

Gamma [0.30 to 0.75]

Adjust the gamma correction level. Specifying smaller values results in a gentler gamma curve for the slope of low-brightness areas and sharper contrast. Specifying larger values results in an expanded gradient for dark areas and produces brighter images. The gamma curve for low-brightness areas will be steeper, and contrast will be softer.

DRS [Off, Low, Mid, High]

Set the DRS function which performs correction when video with high light/dark contrast is displayed. You can select from a [Low], [Mid], or [High] effect level.

Return

Return to the previous menu level.

Picture 3/3 screen

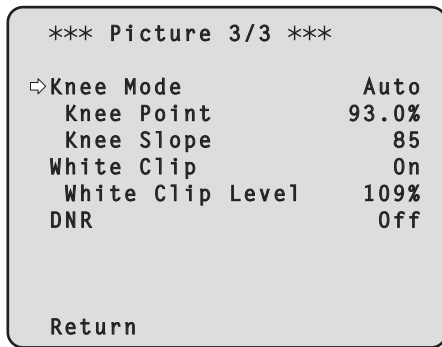

Matrix 1/5 screen

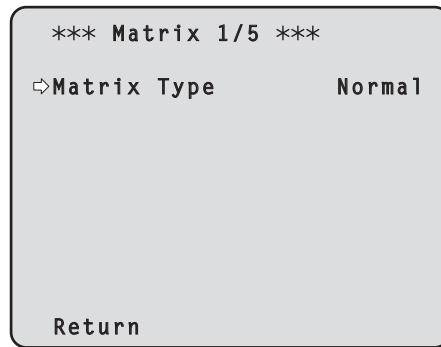

Knee Mode [Off, Auto, Manual]

Set the operating mode for gradation compression (knee).

Off	Turn the knee function off.
Auto	Enable the knee function, and set the knee point and knee slope automatically.
Manual	Enable the knee function, and set the knee point and knee slope manually.

Knee Point [70.0% to 107.0%]

Set the compression level (knee point) position for high-brightness video signals.

This is only enabled when [Knee Mode] is set to [Manual].

Knee Slope [0 to 99]

Set the knee slope.

This is only enabled when [Knee Mode] is set to [Manual].

<NOTE>

- When [DRS] is enabled, the knee setting is disabled.

White Clip [Off, On]

Turn the white clip function off/on.

White Clip Level [90% to 109%]

Set the white clip level.

This is only enabled when [White Clip] is set to [On].

<NOTE>

- When [Knee Mode] is set to [Auto] and the white clip value is changed, the knee value will also change.

DNR [Off, Low, High]

Set the digital noise reduction level for outputting bright, clear images without noise, even at night and low-light conditions.

When [Low] or [High] is selected, noise can be eliminated.

However, image lag may increase.

Return

Return to the previous menu level.

Matrix Type [Normal, EBU, NTSC, User]

Select the type of color matrix.

Normal	This item is used to load the preset color matrix data and compensate for the saturation and color phase.
EBU	
NTSC	
User	On the [Matrix 2/5 screen], the [Linear Matrix] value can be adjusted by the user. On the [Matrix 3/5 screen], [Matrix 4/5 screen] or [Matrix 5/5 screen], the [Color Correction] value can be adjusted by the user.

Return

Return to the previous menu level.

Matrix 2/5 screen

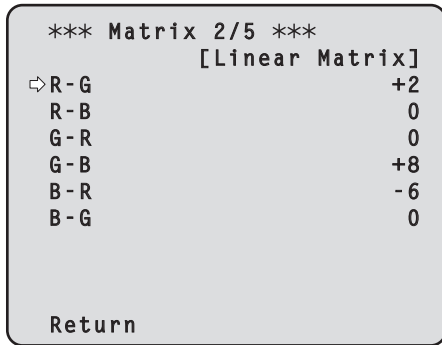

Linear Matrix

This can be set when [User] has been selected as the [Matrix Type] setting.

R-G	Adjust the color to between -63 to +63 for each axis direction.
R-B	
G-R	
G-B	
B-R	
B-G	

Return

Return to the previous menu level.

Matrix 3/5 screen

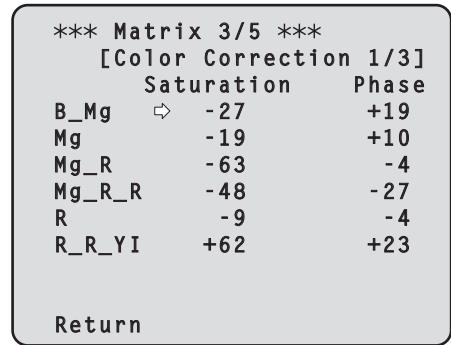

Color Correction 1/3

This can be set when [User] has been selected as the [Matrix Type] setting.

Adjust the saturation and hue.

Saturation [-63 to +63]

Adjust the saturation for each color.

Phase [-63 to +63]

Adjust the hue for each color.

B_Mg	Color between blue and magenta
Mg	Magenta
Mg_R	Color between magenta and red
Mg_R_R	Color with a 1:3 magenta to red ratio
R	Red
R_R_YI	Color with a 3:1 red to yellow ratio

Return

Return to the previous menu level.

Camera menu items (continued)

Matrix 4/5 screen

```

*** Matrix 4/5 ***
  [Color Correction 2/3]
      Saturation   Phase
R_Y1  ⇨  +63      +44
R_Y1_Y1 +44      0
Y1    +63      +29
Y1_G  +17      +20
G      +4      +26
G_Cy   0        0

Return
    
```

Color Correction 2/3

This can be set when [User] has been selected as the [Matrix Type] setting.

Adjust the saturation and hue.

Saturation [-63 to +63]

Adjust the saturation for each color.

Phase [-63 to +63]

Adjust the hue for each color.

R_Y1	Color between red and yellow
R_Y1_Y1	Color with a 1:3 red to yellow ratio
Y1	Yellow
Y1_G	Color between yellow and green
G	Green
G_Cy	Color between green and cyan

Return

Return to the previous menu level.

Matrix 5/5 screen

```

*** Matrix 5/5 ***
  [Color Correction 3/3]
      Saturation   Phase
Cy    ⇨  -21      +8
Cy_B  -15      +49
B     -12      +3

Return
    
```

Color Correction 3/3

This can be set when [User] has been selected as the [Matrix Type] setting.

Adjust the saturation and hue.

Saturation [-63 to +63]

Adjust the saturation for each color.

Phase [-63 to +63]

Adjust the hue for each color.

Cy	Cyan
Cy_B	Color between cyan and blue
B	Blue

Return

Return to the previous menu level.

Camera menu items (continued)

System screen

This menu has items that relate to the genlock phase adjustment and camera's output image settings.

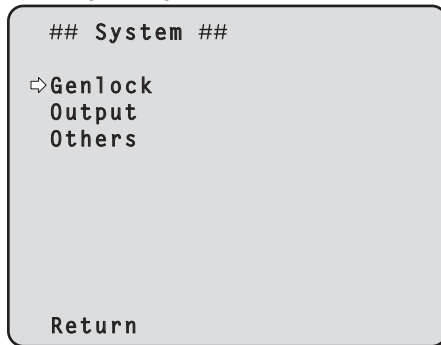

Genlock

This displays the [Genlock] screen on which to perform the phase adjustments.

Output

This displays the [Output] screen on which to select the camera's output image settings.

Others

This displays the [Others] screen on which to select the settings for the installation status of the camera's pan-tilt head unit and operating speed as well as the settings relating to the other functions.

Return

Return to the previous menu level.

Genlock screen

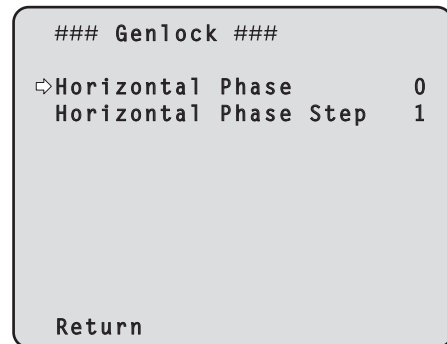

Horizontal Phase [-206 to +49]

This is used to adjust the horizontal phase during genlock.

Horizontal Phase Step [1 to 10]

This is selected to set the amount by which the [Horizontal Phase] setting is to be adjusted.

Return

Return to the previous menu level.

<NOTE>

- The horizontal phases of the HD and SD signals cannot be adjusted separately. Neither is it possible to adjust the chroma phase of the VIDEO OUT signals. The free run setting is used.

Output screen

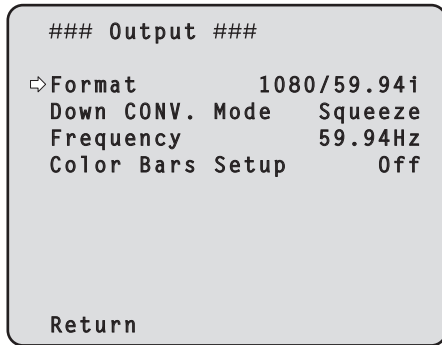

Format

[(For 59.94Hz) 1080/59.94p, 1080/29.97p*¹, 1080/23.98p*², 1080/59.94i, 1080/29.97PsF*², 1080/23.98PsF, 720/59.94p, 480/59.94p(i), (For 50Hz) 1080/50p, 1080/25p*¹, 1080/50i, 1080/25PsF*³, 720/50p, 576/50p(i)]

*¹ Native output

*² OVER 59.94i output (your monitor may recognize the signal as 59.94i).

*³ OVER 50i output (your monitor may recognize the signal as 50i).

The video format is changed on this screen.

For details on how to change the format, refer to “Changing the format” (→ page 55).

In the case of the 480/59.94p(i) or 576/50p(i) format, the P signal is output to the HDMI connector, and the I signal is output to the SDI output and VIDEO output connectors.

Down CONV. Mode

[Squeeze, SideCut, LetterBox]

The down-conversion mode is selected here.

Squeeze	<p>This setting is used when the aspect ratio of the monitor is to be set to 16:9. If the monitor is set to the 4:3 aspect ratio, the images will be squeezed in the width direction and extended in the height direction.</p>
SideCut	<p>This setting is used when the aspect ratio of the monitor is to be set to 4:3. With the vertical height serving as the reference, the parts which extend beyond this at the two sides are cropped changing the view of the angle.</p>
LetterBox	<p>This setting is used when the aspect ratio of the monitor is to be set to 4:3. With the horizontal width serving as the reference, black bands are added at the top and bottom changing the view of the angle.</p>

• The mode switches when the setting is fixed.

Frequency [59.94Hz, 50Hz]

This item is selected to switch the frame frequency.

• When the frequency is switched, [Format] is set as follows.

59.94Hz		50Hz	
1080/59.94p	↔	1080/50p	
1080/29.97p	↔	1080/25p	
1080/23.98p	→	1080/25p	
1080/59.94i	↔	1080/50i	
1080/29.97PsF	↔	1080/25PsF	
1080/23.98PsF	→	1080/25PsF	
720/59.94p	↔	720/50p	
480/59.94p(i)	↔	576/50p(i)	

• For details on how to change the frequency, refer to “Changing the frequency” (→ page 55).

Color Bars Setup [Off, On]

This is only enabled when [Frequency] is set to [59.94Hz].

Select the color bar setup level (Off: 0.0IRE, On: 7.5IRE) for the VIDEO OUT signal.

Return

Return to the previous menu level.

■ Changing the format

When the currently selected format is changed in the [Output] screen, the pre-format-change confirmation screen appears.

Pre-format-change confirmation screen

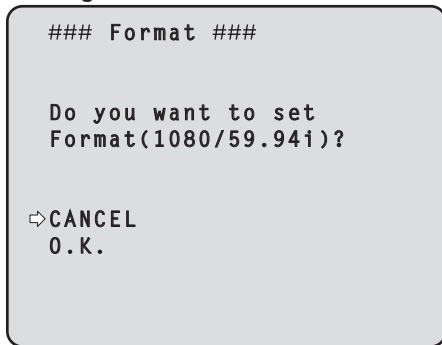

- The format to be set is displayed within the parentheses on the screen.
- When you move the cursor to [O.K.] on the pre-format-change confirmation screen and confirm, the post-format-change confirmation screen appears.

Post-format-change confirmation screen

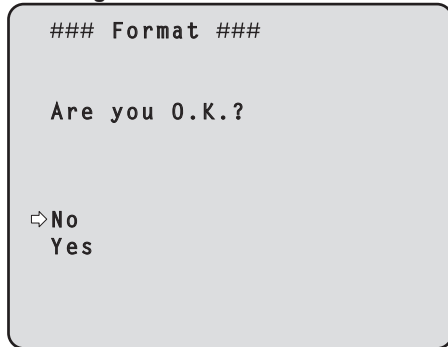

- If you move the cursor to [Yes] and confirm, the display returns to the [Output] screen in the post-change format.
- If you move the cursor to [No] and confirm, the display returns to the [Output] screen in the pre-change format.
The same occurs if an operation is not performed within 10 seconds.
- If an external sync signal that does not match the changed format is input, the image will be distorted.
Change the external sync signal, or perform internal synchronization.

■ Changing the frequency

When the currently selected frequency is changed in the [Output] screen, the pre-frequency-change confirmation screen appears.

Pre-frequency-change confirmation screen

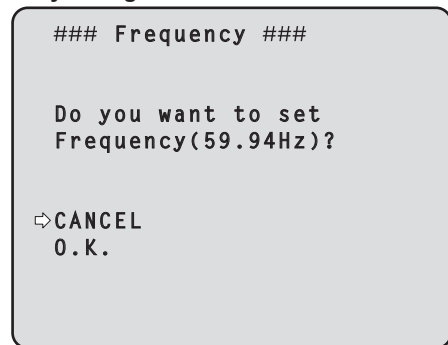

- The frequency to be set is displayed within the parentheses on the screen.
- When you move the cursor to [O.K.] on the pre-frequency-change confirmation screen and confirm, the frequency is changed.

<NOTE>

- When using a monitor that does not support 59.94Hz/50Hz frequencies, images may not be displayed after the frequency is changed. Before changing the frequency, verify that your monitor supports the frequency.

Others 1/4 screen

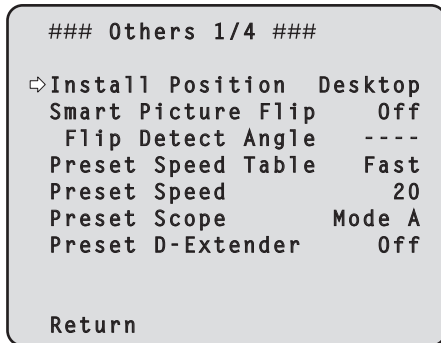

Install Position [Desktop, Hanging]

“Desktop” or “Hanging” is selected here as the method used to install the unit.

Desktop	Stand-alone installation
Hanging	Suspended installation

- When [Hanging] has been selected, the top, bottom, left and right of the images will be reversed, and up/down/left/right control for panning and tilting will also be reversed.

Smart Picture Flip [Off, Auto]

When the tilt becomes the angle set for [Flip Detect Angle], the image will be flipped in the vertical direction automatically.

Off	The picture is not turned upside down (flipped).
Auto	The picture is automatically turned upside down (flipped).

Flip Detect Angle [60° to 120°]

Set the tilt angle at which the image will be flipped in the vertical direction automatically when [Smart Picture Flip] is set to [Auto].

Preset Speed Table [Slow, Fast]

Set the preset speed table (Slow, Fast). During preset playback, presets are performed at [Preset Speed] (1 to 30) values that are based on the table set here.

- When [Preset Speed Table] is set to [Fast], [Preset Speed] values equivalent to the AW-HE120 will be applied.

Preset Speed [1 to 30]

Set the pan/tilt movement speed used when recalling camera orientation information registered to the preset memory (30 steps).

<NOTE>

- When you set large [Preset Speed] values, the image may sway when the movement stops.

Preset Scope [Mode A, Mode B, Mode C]

Selected here are the setting items to be recalled when the contents of the preset memory are regenerated.

Mode A	Pan, Tilt, Zoom (including digital zoom), Focus, Iris, Gain, white balance adjustment value
Mode B	Pan, Tilt, Zoom (including digital zoom), Focus, Iris
Mode C	Pan, Tilt, Zoom (including digital zoom), Focus

Preset D-Extender [Off, On]

Turns the preset digital extender function off/on.

When set to [On], the digital extender function configuration will be recalled when regenerating the preset memory. When set to [Off], the digital extender function configuration will not be recalled when storing the preset memory.

Return

Return to the previous menu level.

Others 2/4 screen

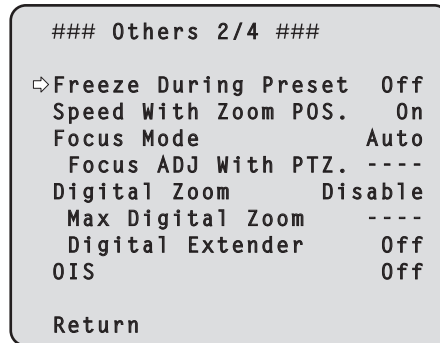

Freeze During Preset [Off, On]

Turn the function for freezing images during preset playback off/on.

When this is set to [On], preset playback is performed with a still of the image immediately preceding the start of preset playback being output. The image freeze is released when preset playback is finished.

Speed With Zoom POS. [Off, On]

“Off” or “On” is set here for the function used to adjust the pan-tilt adjustment speed in conjunction with the zoom magnification.

When [On] is set, the panning and tilting operations will become slower in the zoom status.

This function has no effect during preset operations.

Focus Mode [Auto, Manual]

Select auto or manual mode for the focus adjustment function.

Auto	Always adjust focus automatically.
Manual	Adjust focus manually.

<NOTE>

- [Focus Mode] cannot be set to [Auto] when [Frame Mix] is set to [18dB] or [24dB].

Focus ADJ With PTZ. [Off, On]

“Off” or “On” is set here for the function which compensates for out-of-focusing when it occurs during panning, tilting or zooming operations. When [Off] is set, adjust the focus as required after zooming or set the focus to the auto mode.

This item can be selected only when [Manual] has been selected as the [Focus Mode] setting.

Digital Zoom [Disable, Enable]

“Enable” or “Disable” is set here for the digital zoom function.

If zooming is performed toward the Tele end beyond the maximum position when [Enable] has been selected, the digital zoom can be operated continuously. Zooming will stop temporarily at the position where the optical zoom and digital zoom are switched so after it has stopped at this position, proceed with zooming again.

When the setting is changed to [Disable] while already in the digital zoom region, the zoom will automatically move to the maximum position of the optical zoom.

<NOTE>

- The digital zoom is set to OFF when color bars are displayed during digital zooming.

Max Digital Zoom

[x2, x3, x4, x5, x6, x7, x8, x9, x10]

Set the maximum digital zoom magnification.

Digital Extender [Off, On]

Turn the digital extender function off/on.

When this is set to [On], the digital zoom will be fixed at 1.4x.

When [Digital Zoom] is set to [Enable], [Digital Extender] is disabled.

OIS [Off, On]

Turn the optical image stabilization (OIS) function off/on.

<NOTE>

- The optical image stabilization function's level of correction is reduced during pan/tilt operations.

Return

Return to the previous menu level.

Others 3/4 screen

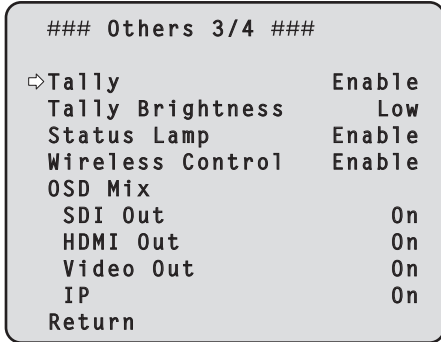

Tally [Disable, Enable]

"Enable" or "Disable" is set here for the function which turns on or turns off the tally lamp using the tally control signal.

Tally Brightness [Low, Mid, High]

Adjust the brightness of the tally LED.

<NOTE>

- When this is set to [Low], the brightness is equivalent to that of the AW-HE120.

Status Lamp [Disable, Enable]

"Enable" or "Disable" is set here for the status lamp.

When you want the status lamp to stay off while this unit is in operation, set to [Disable].

<NOTE>

- Even when set to [Disable], the status lamp may light up when this unit is starting up, updating firmware, or trouble is occurring.

Wireless Control [Disable, Enable]

"Enable" or "Disable" is set here for operations conducted from the wireless remote control.

The operations are enabled when the unit's power is turned on from an external device other than a wireless remote control, and they are disabled when the power is turned on from a wireless remote control.

<NOTE>

- At the point when this item's setting is changed, the new setting is not reflected in operation. It is reflected when the unit is set to the Standby mode and its power is turned on.
- Follow one of the procedures below if the item's setting is changed by mistake and the unit can no longer be operated from a wireless remote control.

When menu operations can be performed using another control device:

→First change the item using a control device capable of performing menu operations, and then turn off the unit's power and turn it back on.

When menu operations cannot be performed using other control devices:

1. Turn off the power of the units and devices that are connected.
2. Disconnect the unit's power cable, and plug it back in.
3. Perform the operation for turning on the unit's power from the wireless remote control.
4. After changing this item, turn off the unit's power and turn it back on.

OSD Mix

Select whether to turn off/on camera menu, status, and other displays for each output image.

SDI Out [Off, On]

HDMI Out [Off, On]

Video Out [Off, On]

IP [Off, On]

Off	The camera menus and statuses are not displayed on the output pictures targeted by the setting items listed above.
On	The camera menus and statuses are displayed for the output pictures covered by the setting items listed above.

<NOTE>

- When this is set to [Off], the camera menu can be displayed for about 1 minute after the unit is turned on.

Return

Return to the previous menu level.

Others 4/4 screen

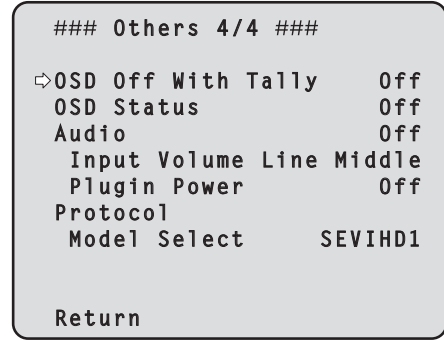

OSD Off With Tally [Off, On]

Off or on the function that turns off camera menu, status, and other displays when tally signals are received via commands or contacts. When the tally signal releases, the camera menu display will return.

OSD Status [Off, On]

Turn the status display during AWB and ABB off/on.

Audio [Off, On]

Turn audio input off/on.

Input Volume

[Mic High, Mic Middle, Mic Low, Line High, Line Middle, Line Low]

Set the mic input, line input, and volume.

Mic High: Use the mic input with the volume set to high.

Mic Middle: Use the mic input with the volume set to medium.

Mic Low: Use the mic input with the volume set to low.

Line High: Use the line input with the volume set to high.

Line Middle: Use the line input with the volume set to medium.

Line Low: Use the line input with the volume set to low.

Plugin Power [Off, On]

Turn the plugin power for the audio off/on.

This is only enabled when [Input Volume] is set to mic input.

Protocol Model Select

[SEVIHD1, SBRC300, SBRCZ330, Reserved1 to Reserved7]

Set the protocol model for standard serial communication.

Appears when the service switch (SW4) at the bottom of the unit is set to ON (standard serial communication).

Do not select [Reserved1] to [Reserved7].

Return

Return to the previous menu level.

Maintenance screen

```
## Maintenance ##  
  
⇨ Firmware Version  
IP Network  
Initialize  
  
Return
```

Firmware Version

This is selected to display the [Firmware Version] screen on which the user can check the version of the firmware which is currently installed in the unit.

IP Network

This is selected to display the [IP Network] screen on which the user can check the [IP Address], [Subnet Mask] and [Default Gateway] settings which have been established in the unit.

Initialize

This is selected to display the [Initialize] screen on which the user can initialize the camera settings.
For details on operation, refer to "Concerning initialization" (→ page 59).

Return

Return to the previous menu level.

Firmware VER 1/2 screen

```
### Firmware VER 1/2 ###  
  
CPU Software  
Interface          V01.00  
Camera Main       V01.00  
Servo             V01.00  
Network           V01.00  
EEPROM  
Interface          V01.00  
  
⇨ Return
```

CPU Software Interface

Display the software version of the interface.

CPU Software Camera Main

Display the software version of the camera unit.

CPU Software Servo

Display the software version of the servo.

CPU Software Network

Display the software version of the network.

EEPROM Interface

Display the EEPROM version of the interface.

Return

Return to the previous menu level.

Firmware VER 2/2 screen

```
### Firmware VER 2/2 ###  
  
FPGA  
Lens              V01.00  
AVIO              V01.00  
Com               V01.00  
  
⇨ Return
```

FPGA Lens

Display the FPGA version of the lens.

FPGA AVIO

Display the FPGA version of the AVIO.

FPGA Com

Display the FPGA version of the communication.

Return

Return to the previous menu level.

IP Network screen

```
### IP Network ###  
  
IP Address  
    192.168.  0. 10  
Subnet Mask  
    255.255.255.  0  
Default Gateway  
    192.168.  0.  1  
  
⇨Return
```

IP Address

This is selected to display the IP address which has been set for the unit.

Subnet Mask

This is selected to display the subnet mask which has been set for the unit.

Default Gateway

This is selected to display the default gateway which has been set for the unit.

<NOTE>

- On this screen, the [IP Address], [Subnet Mask] and [Default Gateway] settings can be displayed but they cannot be changed. To change an address, use "Network setup screen [Network]" (→ page 89) on the Web setting screen [Setup] or "Use the Easy IP Setup Software to establish the unit's settings" (→ page 23).

Return

Return to the previous menu level.

■ Concerning initialization

When [Initialize] is selected on the [Maintenance] screen, the [Initialize] screen appears.

Initialize screen

```
### Initialize ###  
  
Do you want to initialize  
Menu settings?  
  
⇨CANCEL  
O.K.
```

- When the cursor is moved to [O.K.] on the [Initialize] screen and the setting is entered, the [Menu settings initialized] screen is displayed for 5 seconds, and the camera settings are restored to the settings which were established when the camera was purchased. However, the [Format] settings and [Frequency] settings (→ page 54) and network settings are not initialized.

<NOTE>

- Operation returns to the [Top Menu] screen when the initialization operation is completed. At this point, set the unit to the Standby mode, and then set it to the Power ON mode again. (→ page 25)
- The [Format] and [Frequency] settings are not initialized.
- The [AWB] and [ABB] adjustment values are not initialized.

Menu settings initialized screen

```
Menu settings  
initialized
```

- When the cursor is moved to [CANCEL] on the Initialize screen and the setting is entered, the [Menu settings unchanged] screen is displayed for 5 seconds, the initialization operation is not performed, and the [Maintenance] screen returns to the display.

Menu settings unchanged screen

```
Menu settings  
unchanged
```

Camera menu item table

Camera menu				Item	Factory setting	Selection items	
Top Menu	Camera	Scene		Scene	Scene1	Scene1, Scene2, Scene3, Scene4	
		Brightness 1/2	Picture Level	Brightness	0	-50 to +50 (step: 1)	
				Iris Mode	Auto	Manual, Auto	
				Shutter Mode	Off	Off, Step, Synchro, ELC	
				Step/Synchro (When [Shutter Mode] is set to [Step])	[59.94Hz] 1/100 [50Hz] 1/120	When Frequency is set to 59.94 Hz : • 59.94p / 59.94i mode 1/100, 1/120, 1/250, 1/500, 1/1000, 1/2000, 1/4000, 1/10000 • 29.97p mode 1/30, 1/60, 1/120, 1/250, 1/500, 1/1000, 1/2000, 1/4000, 1/10000 • 23.98p mode 1/24, 1/60, 1/120, 1/250, 1/500, 1/1000, 1/2000, 1/4000, 1/10000 When Frequency is set to 50 Hz : • 50p / 50i mode 1/60, 1/120, 1/250, 1/500, 1/1000, 1/2000, 1/4000, 1/10000 • 25p mode 1/25, 1/60, 1/120, 1/250, 1/500, 1/1000, 1/2000, 1/4000, 1/10000	
				Step/Synchro (When [Shutter Mode] is set to [Synchro])	[59.94Hz] 60.15Hz [50Hz] 50.15Hz	When Frequency is set to 59.94 Hz : 60.15 Hz to 642.21 Hz (255 steps) When Frequency is set to 50 Hz : 50.15Hz to 535.71Hz (255 steps)	
				Gain	0dB	Auto, 0dB to 36dB (step: 1dB)	
				AGC Max Gain	18dB	6dB, 12dB, 18dB	
				Frame Mix	Off	Off, 6dB, 12dB, 18dB, 24dB	
				ND Filter	Through	Through, 1/8, 1/64	
				Brightness 2/2	Day/Night	Day	Day, Night
			Picture	Picture 1/3	Chroma Level	0%	OFF, -99% to 40%
					White Balance Mode	AWB A	AWB A, AWB B, ATW, 3200K, 5600K, VAR
					Color Temperature	3200K	2000K to 15000K*1
					R Gain	0	-150 to +150 (step: 1)
		B Gain			0	-150 to +150 (step: 1)	
		Pedestal			0	-150 to +150 (step: 1)	
		R Pedestal			0	-100 to +100 (step: 1)	
		B Pedestal		0	-100 to +100 (step: 1)		
		Picture 2/3		Detail	On	Off, On	
				Master Detail	31	0 to 62	
				V Detail Level	0	-7 to +7	
				Detail Band	0	-7 to +7	
				Noise Suppress	1	0 to 60	
				FleshTone NoiseSUP.	16	0 to 31	
				Gamma Type	HD	HD, SD, FILMLIKE1, FILMLIKE2, FILMLIKE3	
		Gamma		0.45	0.30 to 0.75 (Step: 0.01)		
		DRS		Off	Off, Low, Mid, High		
		Picture 3/3		Knee Mode	Auto	Off, Auto, Manual	
			Knee Point	93.0%	70.0% to 107.0% (Step: 0.5%)		
			Knee Slope	85	0 to 99		
			White Clip	On	Off, On		
			White Clip Level	109%	90% to 109%		
		DNR	Off	Off, Low, High			

*1 Step intervals increase as values become larger.

(2000/2010/2020/2040/2050/2070/2080/2090/2110/2120/2140/2150/2170/2180/2200/2210/2230/2240/2260/2280/2300/2310/2330/2340/2360/2380/
2400/2420/2440/2460/2480/2500/2520/2540/2560/2600/2620/2640/2680/2700/2720/2740/2780/2800/2820/2850/2870/2920/2950/2970/3000/3020/
3070/3100/3120/3150/3200/3250/3270/3330/3360/3420/3450/3510/3570/3600/3660/3720/3780/3840/3870/3930/3990/4050/4110/4170/4240/4320/
4360/4440/4520/4600/4680/4760/4840/4920/5000/5100/5200/5300/5400/5500/5600/5750/5850/6000/6150/6300/6450/6650/6800/7000/7150/7400/
7600/7800/8100/8300/8600/8900/9200/9600/10000/10500/11000/11500/12000/12500/13000/14000/15000)

Camera menu item table (continued)

Camera menu				Item	Factory setting				Selection items	
Top Menu	Camera	Scene	Matrix	Matrix 1/5	Matrix Type	Normal				Normal, EBU, NTSC, User
				Matrix 2/5	[Linear Matrix]	Normal	EBU	NTSC	User	
					R-G	+2	-4	-39	-6	-63 to +63
					R-B	0	-6	-12	+3	-63 to +63
					G-R	0	-4	-4	-6	-63 to +63
					G-B	+8	-2	-6	+5	-63 to +63
					B-R	-6	-4	-6	-12	-63 to +63
					B-G	0	-6	-8	-6	-63 to +63
				Matrix 3/5	[Color Correction 1/3]	Normal	EBU	NTSC	User	
					B_Mg Saturation	-27	-21	-7	-14	-63 to +63
					B_Mg Phase	+19	+4	-38	-5	-63 to +63
					Mg Saturation	-19	0	0	-9	-63 to +63
					Mg Phase	+10	0	0	-9	-63 to +63
					Mg_R Saturation	-63	-63	-8	-29	-63 to +63
					Mg_R Phase	-4	+13	+13	0	-63 to +63
					Mg_R_R Saturation	-48	-13	-62	-34	-63 to +63
					Mg_R_R Phase	-27	+63	0	0	-63 to +63
					R Saturation	-9	-63	-37	-18	-63 to +63
					R Phase	-4	0	+4	-4	-63 to +63
					R_R_YI Saturation	+62	-32	+12	+24	-63 to +63
					R_R_YI Phase	+23	+38	+63	-16	-63 to +63
					Matrix 4/5	[Color Correction 2/3]	Normal	EBU	NTSC	User
				R_YI Saturation		+63	+18	-63	+17	-63 to +63
				R_YI Phase		+44	+35	+9	-13	-63 to +63
				R_YI_YI Saturation		+44	0	0	+9	-63 to +63
				R_YI_YI Phase		0	0	+17	-8	-63 to +63
				YI Saturation		+63	+63	+14	+19	-63 to +63
				YI Phase		+29	+4	-7	-2	-63 to +63
				YI_G Saturation		+17	+9	0	+16	-63 to +63
				YI_G Phase		+20	+22	+16	-2	-63 to +63
				G Saturation		+4	+12	+56	-2	-63 to +63
				G Phase		+26	+4	+13	-4	-63 to +63
				G_Cy Saturation		0	0	0	0	-63 to +63
				G_Cy Phase		0	0	0	-9	-63 to +63
				Matrix 5/5	[Color Correction 3/3]	Normal	EBU	NTSC	User	
					Cy Saturation	-21	+18	-28	-9	-63 to +63
					Cy Phase	+8	+24	+33	+5	-63 to +63
					Cy_B Saturation	-15	-17	-63	-12	-63 to +63
					Cy_B Phase	+49	+61	+63	+5	-63 to +63
					B Saturation	-12	-8	-17	-19	-63 to +63
					B Phase	+3	+7	-8	0	-63 to +63
				Genlock	Horizontal Phase	0				-206 to +49
					Horizontal Phase Step	1				1 to 10
				Output	Format	AW-HE130WP/AW-HE130KP: 1080/59.94i AW-HE130WE/AW-HE130KE: 1080/50i				When Frequency is set to 59.94Hz : 1080/59.94p, 1080/29.97p*2, 1080/23.98p*3, 1080/59.94i, 1080/29.97PsF*3, 1080/23.98PsF, 720/59.94p, 480/59.94p(i) When Frequency is set to 50Hz : 1080/50p, 1080/25p*2, 1080/50i, 1080/25PsF*4, 720/50p, 576/50p(i)
					Down CONV. Mode	Squeeze				Squeeze, Sidecut, Letter Box
					Frequency	AW-HE130WP/AW-HE130KP: 59.94Hz AW-HE130WE/AW-HE130KE: 50Hz				59.94Hz, 50Hz
					Color Bars Setup	Off				Off, On

*2 Native output

*3 OVER 59.94i output (your monitor may recognize the signal as 59.94i).

*4 OVER 50i output (your monitor may recognize the signal as 50i).

Camera menu item table (continued)

Camera menu			Item	Factory setting	Selection items	
Top Menu	System	Others	Others 1/4	Install Position	Desktop	Desktop, Hanging
				Smart Picture Flip	Off	Off, Auto
				Flip Detect Angle	90deg	60 to 120deg (step: 1deg)
				Preset Speed Table	Fast	Slow, Fast
				Preset Speed	20	1 to 30
				Preset Scope	Mode A	Mode A, Mode B, Mode C
			Preset D-Extender	Off	Off, On	
			Others 2/4	Freeze During Preset	Off	Off, On
				Speed With Zoom POS.	On	Off, On
				Focus Mode	Auto	Manual, Auto
				Focus ADJ With PTZ.	Off	Off, On
				Digital Zoom	Disable	Disable, Enable
				Max Digital Zoom	x10	x2 to x10
				Digital Extender	Off	Off, On
			OIS	Off	Off, On	
			Others 3/4	Tally	Enable	Enable, Disable
				Tally Brightness	Low	Low, Mid, High
				Status Lamp	Enable	Enable, Disable
		Wireless Control		Enable	Enable, Disable	
		OSD Mix				
		SDI Out		On	Off, On	
		HDMI Out		On	Off, On	
		Video Out		On	Off, On	
		IP	On	Off, On		
		Others 4/4	OSD Off With Tally	Off	Off, On	
			OSD Status	Off	Off, On	
			Audio	Off	Off, On	
			Input Volume	Line Middle	Mic High, Mic Middle, Mic Low, Line High, Line Middle, Line Low	
			Plugin Power	Off	Off, On	
			Protocol			
			Model Select	SEVIHD1	SEVIHD1, SBRC300, SBRCZ330, Reserved1 to 7	
		Maintenance	Firmware Version	CPU Software		
				Interface	Version at shipping	---
	Camera Main			Version at shipping	---	
	Servo			Version at shipping	---	
	Network			Version at shipping	---	
	EEPROM					
	Interface			Version at shipping	---	
	FPGA					
	Lens			Version at shipping	---	
	AVIO			Version at shipping	---	
	Com			Version at shipping	---	
	IP Network			IP Address	192.168.0.10	
				Subnet Mask	255.255.255.0	
			Default Gateway	192.168.0.1		
	Initialize		---	CANCEL	CANCEL, OK	

Displaying the web screen

With a personal computer connected to the unit, it is possible to view the camera's IP videos or select various settings from the web browser.

The LAN crossover cable is used when connecting a personal computer directly to the unit's LAN connector for IP control, and the LAN straight cable is used when making the connection through a switching hub.

Select an IP address for the personal computer within the private address range while ensuring that it is different from the address of the unit. Set the subnet mask to the same address as the unit.

<NOTE>

- If you need to change the IP address and subnet mask, be sure to ask your dealer to make these changes for you.

Unit's IP address and subnet mask (factory settings)

IP address: 192.168.0.10
Subnet mask: 255.255.255.0
Range of private addresses: 192.168.0.0 to 192.168.0.255

- If the controller and web browser are being used at the same time, the content selected using the controller may not be reflected on the web browser display.
When using both the controller and web browser, be absolutely sure to check the settings using the controller or camera menu.

For details of the required personal computer environment, refer to page 9.

<NOTE>

- Some functions on the web setting screen can be used only from a personal computer which is running Windows.
(They cannot be used from a personal computer which is running OS X (Mac).)
Functions which can be used by Windows only are indicated using the **Windows** mark.
- The "Network Camera View 4S" plug-in viewer software must have already been installed in order to display the unit's IP videos using a personal computer which is running Windows.
(This is not required for a personal computer which is running OS X (Mac).)
For further details, refer to "Installing the plug-in viewer software" (→ page 24).

Displaying the web screen using a personal computer

The procedure is explained here using Windows screens (Internet Explorer), but it is the same when using the Mac (Safari)*1 screens.

*1 There may be differences in some parts of the screen displays.

1. Start the web browser of the personal computer.

Use one of the web browsers below depending on the operating system installed in the personal computer.

Operating system installed	Web browser
Windows	Internet Explorer
OS X (Mac)	Safari

2. Enter the IP address you configured on the Easy IP Setup Software in the address bar of the web browser.

IPv4 address entry example:

http://URL registered with IPv4 address
http://192.168.0.10/

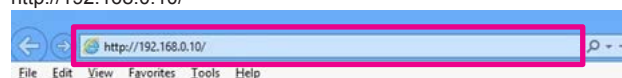

IPv6 address entry example:

http://[URL registered with IPv6 address]
http://[2001:db8::10]/



<NOTE>

- If the HTTP port number has been changed from "80", enter "http://<camera IP address>:<port number>" in the address bar.
Example: When the port number is set to 8080 :
http://192.168.0.11:8080
- If the unit is located on the local network, configure proxy server settings on the web browser ([Tool] - [Internet Options]) in the menu bar so that a proxy server is not used for the local address.
- For details on when [HTTPS] - [Connection] (→ page 93) is set to [HTTPS] in the [Advanced] tab of the Network screen, see "Accessing the Camera by HTTPS" (→ page 98).

3. Press the [Enter] key.

The web screen appears.

The live screen [Live] (→ page 65) is displayed initially. You can switch to the web setup screen [Setup] (→ page 70) when necessary. (→ page 64)



<NOTE>

- If the personal computer does not have the plug-in viewer software already installed, an installation confirmation message is displayed before the live screen [Live] is displayed. In a case like this, follow the on-screen instructions to install the software. [Windows](#)
For further details, refer to (→ page 24).
- When [User auth.] (→ page 87) is set to [On], the user name and password input screen is displayed before the live screen [Live] appears.

The default settings for the user name and password are as follows.

User name	admin
Password	12345

- While the initial settings remain used for the user name and password, a message prompting the user to change the user name and password is displayed after authorization. In order to ensure security, the password for the user name of “admin” must be changed without fail. It is also recommended that the password be changed at regular intervals.
- When an attempt is made to display multiple H.264 images on one personal computer, IP videos may not be displayed depending on the performance of the personal computer concerned. [Windows](#)
- When an item which is underlined on the screen is clicked, a separate window opens, and an input example is displayed.
- Up to 14 users (consisting of users receiving H.264 images and users receiving JPEG images) can access the unit at the same time. However, the number of users that can access the unit may be less than 14 depending on the [Bandwidth control (bit rate)] and [Max bit rate (per client)] settings. A message indicating the access limit will appear if the number of users exceeds 14. When [Transmission type] is set to [Multicast port] for [H.264], the second and subsequent users receiving H.264 images will not be counted toward the total access count.
- When [H.264 transmission] (→ page 73) is set to [On], H.264 images are displayed. When it is set to [Off], JPEG images will be displayed. JPEG images can be displayed even when [H.264 transmission] is set to [On]. In such cases, however, the maximum frame rate of the JPEG images will be 5 fps. [Windows](#)
- The JPEG image frame rate may be slower depending on the network environment, performance of your personal computer, subject of the video, and access volume.

<JPEG image frame rate>

When [H.264 transmission] is set to [On] [Windows](#)

Up to 5 fps

When [H.264 transmission] is set to [Off] [Windows](#)

Up to 30 fps

Switching between the Live screen [Live] and Web setup screen [Setup]

When the live screen [Live] is displayed, click the [Setup](#) button.
For details on the web setup screen [Setup], see “Web setup screen [Setup]” (→ page 70).

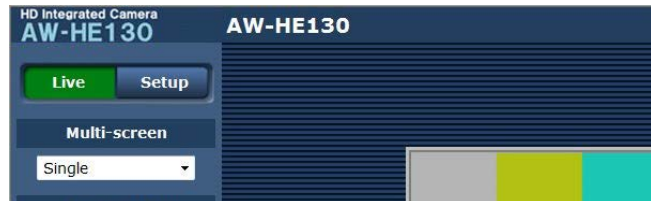

When the web setup screen [Setup] is displayed, click the [Live](#) button.

For details on the live screen [Live], see “Live screen [Live]” (→page 65, page 69).



<NOTE>

- During Standby mode, the [Setup] button is disabled, and you cannot switch to the web setup screen [Setup].
- If the unit is switched to Standby mode from another terminal while the web setup screen [Setup] is displayed, the display will switch to the live screen [Live] after a few seconds.

Web screen operations

The live screen [Live] includes a "single display mode" that displays IP images from a single camera and a "multi display mode" that displays IP images from multiple cameras.

See below for details on the single display mode, and see page 69 for details on the multi display mode.

Live screen [Live] : Single display mode

You can display images from the camera on a personal computer and perform camera operations, such as pan, tilt, zoom, and focus control. The items displayed on the screen will differ depending on whether the [H.264] or [JPEG] button is selected under [Compression].

When [H.264] is selected Windows

The screenshot shows the web interface for the AW-HE130 camera. The main display area (11) shows a color calibration chart. The interface is divided into several menu sections:

- (OSD menu):** Contains buttons for Live/Setup (7), OSD Menu Operation (On/Off, Cancel, navigation arrows) (8), CAM / BAR (CAM, BAR) (8), Stream Menu >> (1), Power (Power ON, Standby) (9), and Op. Lock (10).
- (Stream menu):** Contains Multi-screen (Single) (2), Compression (H.264, JPEG) (3), stream (1, 2, 3, 4) (4), OSD Menu >> (1), and Power (Power ON, Standby) (9).
- Control Panel (12-18):** Includes D-Ext. (x1.0), Zoom, D-Zoom, Focus (Near, O.I. AF, Far), Brightness (Auto), Preset (Home, Move), Scene (Scene1, Set), and Speed (Slow).
- Navigation (14):** A central directional pad for camera movement.
- System Icons (19-21):** Located at the top right, including a camera icon (19), a microphone icon (20), and a signal strength icon (21).

When [JPEG] is selected

The screenshot shows the web interface for the AW-HE130 camera in JPEG mode. The main display area (11) shows a color calibration chart. The interface is divided into several menu sections:

- (OSD menu):** Contains buttons for Live/Setup (7), OSD Menu Operation (On/Off, Cancel, navigation arrows) (8), CAM / BAR (CAM, BAR) (8), Stream Menu >> (1), Power (Power ON, Standby) (9), and Op. Lock (10).
- (Stream menu):** Contains Multi-screen (Single) (2), Compression (H.264, JPEG) (3), Image Capture Size (320x180, 640x360, 1920x1080) (6), Image quality (1, 2) (5), OSD Menu >> (1), and Power (Power ON, Standby) (9).
- Control Panel (12-18):** Includes D-Ext. (x1.0), Zoom, D-Zoom, Focus (Near, O.I. AF, Far), Brightness (Auto), Preset (Home, Move), Scene (Scene1, Set), and Speed (Slow).
- Navigation (14):** A central directional pad for camera movement.
- System Icons (19-21):** Located at the top right, including a camera icon (19), a microphone icon (20), and a signal strength icon (21).

1. Menu switching [OSD Menu >>] / [Stream Menu >>]



Switch between menu displays.

Clicking [OSD Menu >>] when the Stream menu is displayed displays the OSD menu.

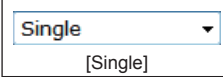
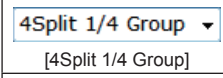
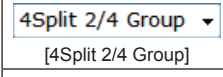

Clicking [Stream Menu >>] when the OSD menu is displayed displays the Stream menu.

2. Multi-Screen list box [Multi-screen]

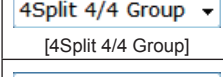
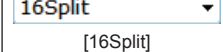
The live screen [Live] display method is selected here.

 [Single]	The IP videos of the connected camera are displayed.
 [4Split 1/4 Group]	You can view multiple IP videos on a single screen by configuring the cameras for multi-screen display beforehand in the [Multi-screen setup] screen (→page 86). (Multi display mode)
 [4Split 2/4 Group]	
 [4Split 3/4 Group]	
 [4Split 4/4 Group]	
 [16Split]	

3. Compression button [Compression]

 [H264]	When selected, the text on the button turns green, and H.264 images are displayed. Windows The [H.264] button is enabled when the [H.264 transmission] setting of [H.264 (1)] to [H.264 (4)] on the Video over IP is [On]. (→ page 73)
 [JPEG]	When selected, the text on the button turns green, and JPEG images are displayed.



<NOTE>

- In the following cases, the selection status of the [Compression] buttons will return to the setting configured in the [Video over IP] tab - [Initial display settings for "Live" page] - [Stream]. [Windows](#)
 - When returning from another screen
 - When the screen is updated

4. Stream buttons [Stream]

These buttons appear only when H.264 images are displayed.

[Windows](#)

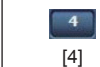

 [1]	When selected, the text on the button turns green, and the images in the main area appear according to the settings configured for [H.264(1)]. (→ page 73)
 [2]	When selected, the text on the button turns green, and the images in the main area appear according to the settings configured for [H.264(2)]. (→ page 73)
 [3]	When selected, the text on the button turns green, and the images in the main area appear according to the settings configured for [H.264(3)]. (→ page 73)
 [4]	When selected, the text on the button turns green, and the images in the main area appear according to the settings configured for [H.264(4)]. (→ page 73)

<NOTE>

- In the following cases, the selection status of the [Stream] buttons will return to the setting configured in the [Video over IP] tab - [Initial display settings for "Live" page] - [Stream].
 - When returning from another screen
 - When the screen is updated
- If the H.264 image resolution is set to [1920x1080] or [1280x720], the image may be compressed depending on the size of the web browser window.

5. Image quality buttons [Image quality]



These buttons appear only when JPEG images are displayed.

 [1]	When selected, images appear according to the settings configured for [Quality1] in the [Image quality(JPEG)] settings (→ page 73).
 [2]	When selected, images appear according to the settings configured for [Quality2] in the [Image quality(JPEG)] settings (→ page 73).

- In the following cases, the selection status of the [Image quality] button will return to the setting configured in the [Video over IP] tab - [Initial display settings for "Live" page] - [Image quality(JPEG)].
 - When returning from another screen
 - When the screen is updated

6. Image Capture Size buttons [Image Capture Size]

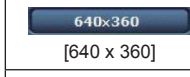
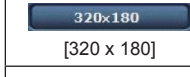
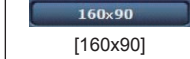

These buttons appear only when JPEG images are displayed.

 [1920 x 1080]	When selected, the text on the button turns green, and the images in the main area appear in 1920 x 1080 size.
 [1280 x 720]	When selected, the text on the button turns green, and the images in the main area appear in 1280 x 720 size.
 [640 x 360]	When selected, the text on the button turns green, and the images in the main area appear in 640 x 360 size.
 [320 x 180]	When selected, the text on the button turns green, and the images in the main area appear in 320 x 180 size.
 [160x90]	When selected, the text on the button turns green, and the images in the main area appear in 160 x 90 size.

<NOTE>

- The resolution selected with [JPEG(1)], [JPEG(2)], and [JPEG(3)] under [JPEG] in the [Video over IP] tab will be used.
- If the resolution is set to [1920x1080] or [1280x720], the image may be compressed depending on the size of the web browser window.
- In the following cases, the selection status of the [Image Capture Size] buttons will return to the setting configured in the [Video over IP] tab - [Initial display settings for "Live" page] - [Stream].
 - When returning from another screen
 - When the screen is updated

7. OSD Menu Operation [OSD Menu Operation]

 [On / Off]	Use this to select whether the camera's on-screen displays are to be shown.
 [Cancel]	It cancels the selection of the setting which is being changed. It restores the pre-change setting.
 [←/→/↑/↓/OK]	Use these to perform the menu operations. The items are selected using the [←/→/↑/↓] buttons. If a selected item has a sub menu, this sub menu is displayed by pressing the [OK] button. When the cursor is moved to any item on the bottom-level setting screen and the [OK] button is pressed, the setting of the selected item starts flashing. A setting for a regular menu item is reflected immediately if it is changed while it is still flashing. However, there are a number of menu items (Scene, Format and Initialize) whose setting is reflected only after the [OK] button has been pressed, causing the setting to stop flashing and the new setting to be entered.

8. Camera button / Color bar button [CAM/BAR]

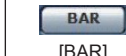
 [CAM]	Use this to output the camera pictures.
 [BAR]	Use this to output the color bar signals.

9. Power ON button [Power ON] / Standby button [Standby]

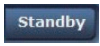
 [Power ON]	Turn the unit on.
 [Standby]	Set the unit to Standby mode.

In the Standby mode, all the buttons on the live screen [Live] except for the [Multi-screen] list box, [Power ON] button, [Standby] button and [Op. Lock] button are disabled.

<NOTE>

- If [Power ON] or [Standby] is selected too quickly, the status selected and the display shown may not correspond. In a case like this, follow the steps below to restore the correct status display:

For Windows:

Press the [F5] key on the keyboard of the personal computer.

For Mac:

Press the [Command] + [R] keys on the keyboard of the personal computer.

- **When operation is transferred to the Standby mode:**

The current zoom, focus and iris positions are stored in the memory (Power ON preset).

- **When operation is transferred to the Power ON mode:**

The zoom, focus and iris are adjusted to the positions which were stored in the memory (Power ON preset) when operation was transferred to the Standby mode.

10.Operation lock button [Op. Lock]

 [Op. Lock]	Use this to lock the operation of the pan, tilt, zoom, focus, brightness, speed, preset and scene operations on the control screen. Use this also to lock the on-screen display menu operations, [CAM/BAR] button and [Power ON] button / [Standby] button to prevent operations from being performed by accident.
---	---

11.Main area (IP video display area)

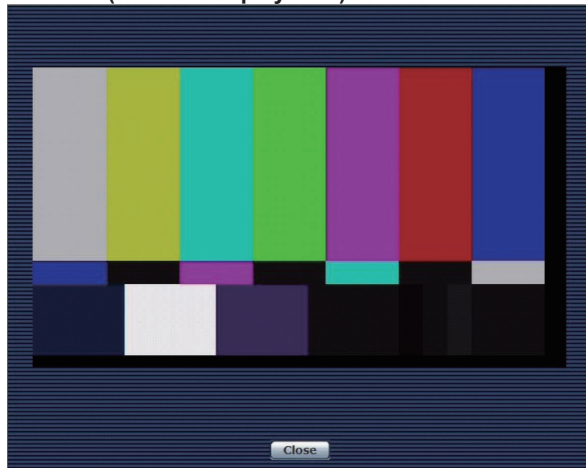





The IP video of the connected camera will be displayed. While the tally lamp is on, the area frame will turn red. When the tally lamp is off, the display area will return to normal. Operating the mouse wheel inside the display area allows you to use the plug-in viewer software's digital zoom. [Windows](#)





<NOTE>

- When the shooting scenes vary significantly, restrictions imposed by the graphics processing (GDI) of the operating system installed may give rise to a phenomenon called "screen tearing" (where parts of the picture are not displayed in synchronization) although this will depend on the personal computer used.
- On a personal computer running Windows, if [H.264 transmission] (→ page 73) is set to [On], H.264 images and JPEG images can be displayed. When it is set to [Off], only JPEG images will appear.
- On a personal computer running OS X (Mac), regardless of the [H.264 transmission] settings, only JPEG images will appear. (H.264 images will not appear.)
- When [H.264 transmission] is set to [On], the frame rate for JPEG images may drop, regardless of whether H.264 images are being transmitted.
- The speed at which the JPEG images are refreshed may be reduced depending on the network environment, performance of the personal computer used, subjects and number of access users.
- Up to 14 users (consisting of users receiving H.264 images and users receiving JPEG images) can access the unit at the same time. (The maximum number of Android terminals which can be connected to the unit at the same time is one.) However, depending on the settings for the [Bandwidth control (bit rate)] and [Max bit rate (per client)], the number of users who can access the unit may be limited to less than 14.
- If the maximum number of users who can access the unit has exceeded the upper limit, a message advising that the unit is being accessed by more users than the maximum number allowed is displayed. [Windows](#)
- In the case of a personal computer which is running OS X (Mac), the " ? " icon appears in the center of the main area which is displayed on a black screen.
- When [Disable] is selected for [Tally] (→page 57, page 85), the camera's tally lamp will not light even when the tally signal is input. However, the area frame of the main area (IP video display area) will turn red.

12.Zoom [Zoom]

 [D-Zoom]	Use this to enable or disable the digital zoom.
 [D-Extender]	Use this to enable or disable the digital extender.
 [x1.0]	Use this to adjust the zoom (magnification) to 1.0x.
 [-]	Use this to adjust the zoom (magnification) in the Wide direction.
 [+]	Use this to adjust the zoom (magnification) in the Tele direction.

13.Focus [Focus]

 [Auto]	Use this to switch between auto and manual focusing. When Auto is selected, the focus is adjusted automatically.
 [Near]	Use this to adjust the focus in the Near direction. It does not work during automatic adjustments.
 [O.T.AF]	When this is pressed while the focus is being adjusted manually, the focus will be temporarily adjusted automatically. It does not work during automatic adjustments.
 [Far]	Use this to adjust the focus in the Far direction. It does not work during automatic adjustments.



14. Control pad and its buttons

	<p>To adjust the image in the horizontal or vertical direction (panning or tilting), left-click the pad and the buttons.</p> <p>The more the outside of the pad is clicked, the faster the camera operates. Adjustment is also possible by dragging the mouse.</p> <p>Right-click the pad to initiate zooming and focusing.</p> <p>When the top half of the pad is clicked in the up or down direction, the zoom (magnification) is adjusted in the Tele direction; conversely, when the bottom half of the pad is clicked, the zoom is adjusted in the Wide direction.</p> <p>When the left half of the pad is clicked in the left or right direction, the focus is adjusted in the Near direction; conversely when the right half of the pad is clicked, the focus is adjusted in the Far direction. The zooming can also be adjusted by operating the mouse wheel.</p>
---	---

<NOTE>

- When the mouse is used for dragging and dropping from the control pad area to a position outside this area, the panning, tilting and other operations will not stop.
- In a case like this, click the control pad area to stop these operations.



15. Brightness [Brightness]

 [-]	<p>Use this to make the image darker. It does not work during automatic adjustments.</p>
 [+]	<p>Use this to make the image lighter. It does not work during automatic adjustments.</p>
 [Auto]	<p>Use this to switch the brightness adjustment between auto and manual. When Auto is selected, the picture brightness is adjusted automatically.</p>



16. Speed [Speed]

 [Slow]	<p>Use this to select the speed at which the pan, tilt, zoom, focus, and brightness operations are to be performed.</p>
---	---

17. Preset [Preset]

 [Home]	<p>When the preset position is selected from the pull-down menu and the [Move] button is clicked, the camera direction moves to the preset position which was registered ahead of time.</p> <p>Preset positions are registered on the preset position screen.</p>
 [Move]	<p>The camera direction moves to the preset position which is now selected on the pull-down menu.</p> <p>The settings that are reproduced at this position are the settings which were established on the [Preset Scope] menu (→ page 56, page 82, page 84).</p> <p>The camera direction moves to the home position if [Home] has been selected on the pull-down menu.</p> <p>In such cases, the image output during movement to the home position will not freeze, regardless of the [Freeze During Preset] setting.</p>

18. Scene [Scene]

 [Scene1]	<p>Select a shooting mode from the pull-down menu, and click the [Set] button to switch to the selected mode.</p>
 [Set]	<p>The shooting mode switches to the one selected in the pull-down menu.</p>

19. Full-screen display button Windows

	<p>Display the image in full-screen mode.</p> <p>When the image displayed in the main area is compressed, clicking this once displays the image at the correct resolution in the main area. When the image is displayed at the correct resolution, the image is displayed in full-screen mode. To return to the Live screen, press the [Esc] key on the personal computer while the image is displayed in full-screen mode.</p> <p>The aspect ratio of the displayed image will be adjusted according to the monitor size.</p>
---	--



20. Snapshot button Windows

	<p>Capture a snapshot (single still image), and display it in a separate window. A menu appears when you right-click the image, and you can select [Save] to save the image to the personal computer.</p> <p>You can also click [Print] to output from a printer.</p>
---	---

<NOTE>

- The following settings may be necessary.
- In the Internet Explorer menu bar, click [Tools] - [Internet Options] - [Security] tab, select [Trusted Sites], and then click [Sites]. Register the camera's address under [Websites] in the window that appears.
- Depending on the network environment, for example, if snapshot capture takes longer than a certain amount of time, the image may not appear.
- When [JPEG transmission(1)] is set to [Off], the image captured with the snapshot button will be black.

21. Audio button Windows

	<p>Turn the audio on/off. (→page 57, page 76)</p> <p>When you click this button, the button display changes to , and audio from the unit cannot be heard from the personal computer.</p> <p>Move the cursor () to adjust the volume to one of three levels.</p>
---	--

Live screen [Live] : Multi display mode

In this mode, the images of a multiple number of cameras can be monitored on one screen (called the 'multi screen').

The image of 4 cameras or max. 16 cameras can be monitored at one time.

When the camera title of any of the images is clicked, the live screen [Live] (single display mode) of the camera concerned is displayed as a separate window.

In order to use the multi screen, the cameras whose images are to be shown on the multi screen must be set ahead of time.

With one group consisting of 4 cameras, up to four groups of cameras (a total of 16 cameras) can be registered. (→ page 86)

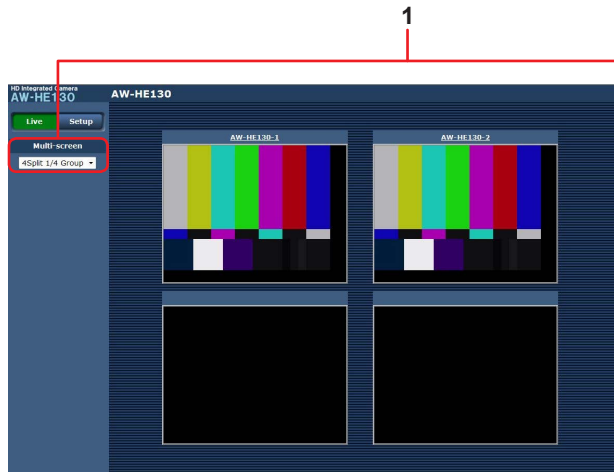

Multi screen consisting of 4 sub-screens

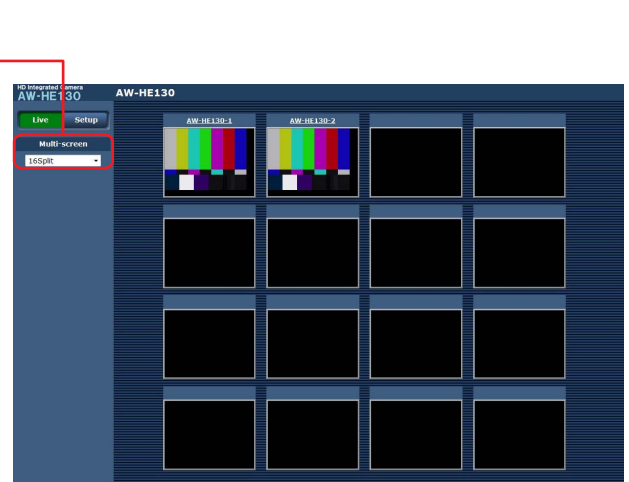

Multi screen consisting of 16 sub-screens

1. Multi-Screen list box [Multi-screen]

The live screen [Live] display method is selected here.

<p>Single</p> <p>(Single)</p>	<p>The IP videos of the connected camera are displayed.</p>
<p>4Split 1/4 Group</p> <p>(4Split 4/1 Group)</p>	<p>When the cameras for multi-screen display have been set ahead of time using the multi-screen(→ page 86), it is possible to view a multiple number of IP videos on a single screen. (Multi display mode)</p>
<p>4Split 2/4 Group</p> <p>(4Split 4/2 Group)</p>	
<p>4Split 3/4 Group</p> <p>(4Split 4/3 Group)</p>	
<p>4Split 4/4 Group</p> <p>(4Split 4/4 Group)</p>	
<p>16Split</p> <p>(16Split)</p>	

<NOTE>

- The IP videos displayed on the multi screen are JPEG images only.
- IP images are in JPEG format only and audio is not output.
- Images are stretched vertically to fit the [4:3] aspect ratio of the multi screens.
- It is not possible to transfer from the live screen [Live] to the multi screen if the unit's power has been turned off, or the network cable has been disconnected, while IP videos are being displayed.
- When [JPEG transmission(1)], [JPEG transmission(2)] or [JPEG transmission(3)] is set to [Off], the multi screen may not display. Set all to [On] to use the multi screen.

Web screen configurations

Logging into the Web setup screen [Setup]

1. Click the [Setup] button. (→ page 64)

The login screen appears.



2. Enter the user name and password.

The default settings for the user name and password are as follows.

User name	admin
Password	12345

3. Click the [OK] button.

Click [OK] again when the following screen appears.

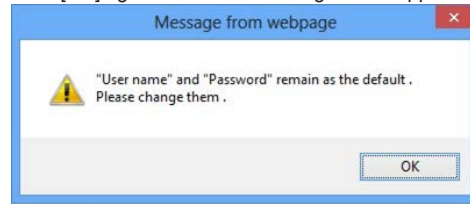

<NOTE>

- While the initial settings remain used for the user name and password, a message prompting the user to change the user name and password is displayed after authorization. In order to ensure security, the password for the user name of "admin" must be changed without fail. It is also recommended that the password be changed at regular intervals.
- During Standby mode, the [Setup] button is disabled, and you cannot switch to the web setup screen [Setup].

Web setup screen [Setup]

The settings for the unit are selected on this screen.

<NOTE>

- The setting menu operations can be performed only by users whose access level is "1. Administrator". For the procedure used to set the access level, refer to page 87.

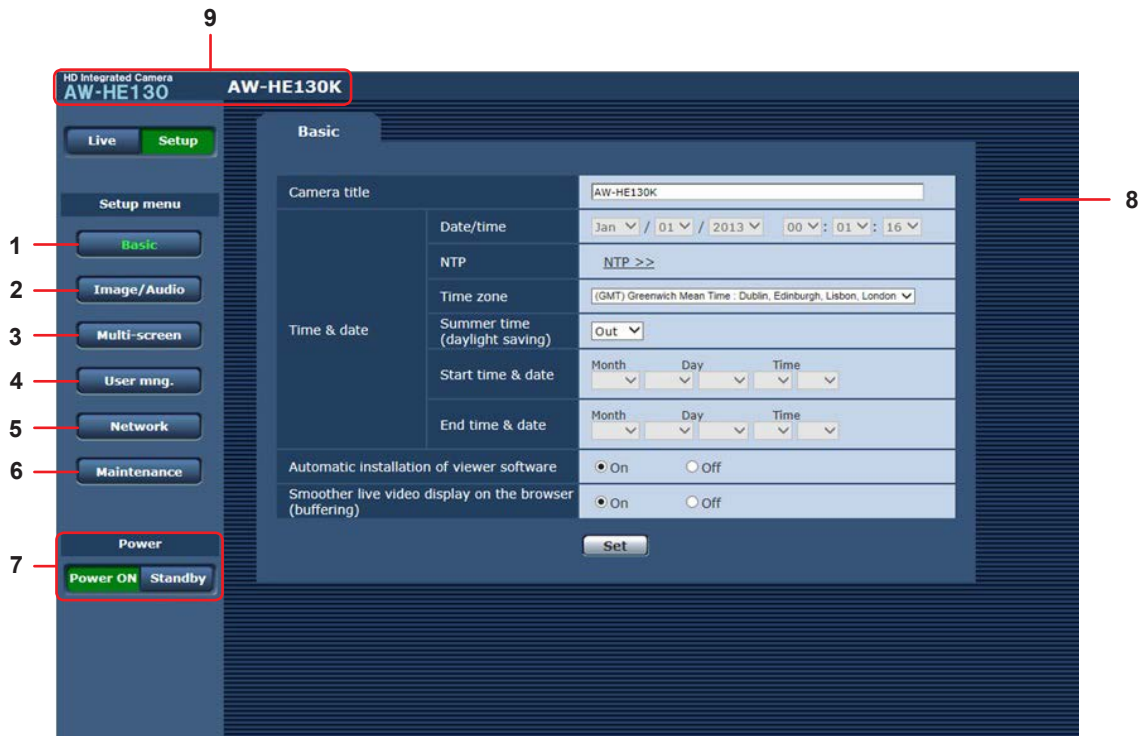

1. Basic button [Basic]

When the Basic button is pressed, the Basic screen is displayed in the main area.

→ "Basic screen" (→ page 71)

2. Image/Audio button [Image/Audio]

When the Image/Audio button is pressed, the Image screen is displayed in the main area.

→ "Image screen" (→ page 72)

3. Multi-Screen button [Multi-Screen]

When the Multi-Screen button is pressed, the Multi-Screen setup screen is displayed in the main area.

→ "Multi-Screen setup screen" (→ page 86)

4. User mng. button [User mng.]

When the User mng. button is pressed, the User mng. screen is displayed in the main area.

→ "User mng. screen" (→ page 87)

5. Network button [Network]

When the Network button is pressed, the Network setup screen is displayed in the main area.

→ "Network setup screen" (→ page 89)

6. Maintenance button [Maintenance]

When the Maintenance button is pressed, the Maintenance screen is displayed in the main area.

→ "Maintenance screen" (→ page 101)

7. Power ON button [Power ON] / Standby button [Standby]

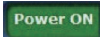
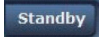
 [Power ON]	Turn the unit on.
 [Standby]	Set the unit to Standby mode.

When you enter Standby mode, the display will automatically switch to Live mode. In addition, the [Setup] button in the live screen [Live] will be disabled, and you cannot operate the web setup screen [Setup].

8. Main area

The menu screen is displayed.

9. Camera title display area

The name for the unit configured in the Basic screen [Basic] (→ page 71) appears.



Basic screen [Basic]

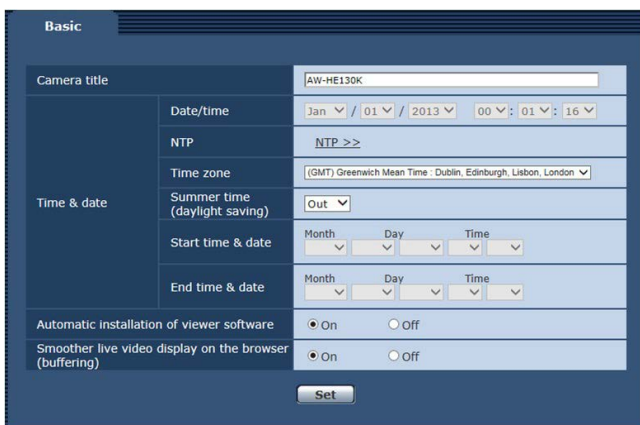

Camera title

Input the name of the camera here.

When the [Set] button is clicked, the input name appears in the camera title display area.

- The factory default setting is the model number of the unit.
- You can enter between 0 to 20 half-size characters.
- The following characters can be displayed.

Half-size numeric characters	0123456789
Half-size alphabetical characters (upper and lower cases)	ABCDEFGHIJKLMNOPQRSTUVWXYZ abcdefghijklmnopqrstuvwxyz
Symbols	!#\$%&'()*+,-./:;<=>?@[]^_`{ }~

Time & date - Date/time

Enters the current date and time.

Setting range: Jan/01/2013 00:00:00 to Dec/31/2035 23:59:59

<NOTE>

- If you require a more accurate date and time for your system's operations, use an NTP server.

Time & date - NTP

When [NTP >>] is clicked, you will be moved to the [NTP] setting page in the [Advanced] tab of the Network setup screen [Network]. (→ page 91)

Time & date - Time zone

Selects the time zone according to the region where the camera is being used.

Factory settings:

(GMT) Greenwich Mean Time: Dublin, Edinburgh, Lisbon, London

Time & date - Summer time (daylight saving)

Sets whether to use summer time.

Sets summer time based on the region.

Setting value:

In	Sets the time to summer time.
Out	Cancels summer time.
Auto	Switches to summer time according to the start/end time and date settings (time, day, week, month).

Factory settings: Out

Time & date - Start time & date

Time & date - End time & date

Sets the summer time start/end time and date by time, day, week and month when [Auto] is selected in the [Summer time (daylight saving)] setting.

Automatic installation of viewer software

One of the following settings is selected for the automatic installation of the plug-in viewer software.

Setting value:

On	The plug-in viewer software is automatically installed.
Off	The plug-in viewer software is not automatically installed.

Factory settings: On

Smoother live video display on the browser (buffering)

Configure settings for displaying images from the unit on the plug-in viewer software.

Setting value:

On	Temporarily store images from the unit onto the personal computer for smoother display.
Off	Do not temporarily store images from the unit onto the personal computer, and display them in real time.

Factory settings: On

<NOTE>

- Images and audio cannot be viewed or heard on personal computers on which the "Network Camera View 4S" plug-in viewer software is not installed.
- You can view the number of times the plug-in software was installed under the [Product info.] tab in the [Maintenance] menu of the unit's Web setting screen [Setup].

Image screen [Image]

■ IP video settings tab [Video over IP]

The JPEG image and H.264 image settings as well as the settings related to image quality are selected on this screen.

Video over IP Audio Image/Position System

Initial display settings for "Live" page

Stream: H.264(1) | Refresh interval (JPEG) *: 5fps | Image quality (JPEG): Quality 1

JPEG

JPEG(1): JPEG transmission: On | Image capture size: 1920x1080 | Image quality: Quality 1: 5 Normal | Quality 2: 8

JPEG(2): JPEG transmission: On | Image capture size: 640x360 | Image quality: Quality 1: 5 Normal | Quality 2: 8

JPEG(3): JPEG transmission: On | Image capture size: 320x180 | Image quality: Quality 1: 5 Normal | Quality 2: 8

H.264(1)

H.264 transmission: On | Internet mode (over HTTP): Off | Image capture size: 1920x1080 | Transmission priority: Frame rate | Burst tolerance level: Low | Control time period: 24h | Frame rate: 60fps | Max bit rate (per client) *: Max 4096kbps - Min 1024kbps | Image quality: Normal | Refresh interval: 1s | Transmission type: Unicast port (AUTO) | Unicast port(Image): 32004 (1024-50000) | Unicast port(Audio): 33004 (1024-50000) | Multicast address: 239.192.0.20 | Multicast port: 37004 (1024-50000) | Multicast TTL/HOPLimit: 16 (1-254)

H.264(2)

H.264 transmission: On | Internet mode (over HTTP): Off | Image capture size: 640x360 | Transmission priority: Frame rate | Burst tolerance level: Low | Control time period: 24h | Frame rate: 30fps | Max bit rate (per client) *: Max 1536kbps - Min 512kbps | Image quality: Normal | Refresh interval: 1s | Transmission type: Unicast port (AUTO) | Unicast port(Image): 32014 (1024-50000) | Unicast port(Audio): 33014 (1024-50000) | Multicast address: 239.192.0.21 | Multicast port: 37004 (1024-50000) | Multicast TTL/HOPLimit: 16 (1-254)

H.264(3)

H.264 transmission: On | Internet mode (over HTTP): Off | Image capture size: 320x180 | Transmission priority: Frame rate | Burst tolerance level: Low | Control time period: 24h | Frame rate: 30fps | Max bit rate (per client) *: Max 1024kbps - Min 128kbps | Image quality: Normal | Refresh interval: 1s | Transmission type: Unicast port (AUTO) | Unicast port(Image): 32024 (1024-50000) | Unicast port(Audio): 33024 (1024-50000) | Multicast address: 239.192.0.22 | Multicast port: 37004 (1024-50000) | Multicast TTL/HOPLimit: 16 (1-254)

H.264(4)

H.264 transmission: On | Internet mode (over HTTP): Off | Image capture size: 160x90 | Transmission priority: Frame rate | Burst tolerance level: Low | Control time period: 24h | Frame rate: 30fps | Max bit rate (per client) *: Max 512kbps - Min 128kbps | Image quality: Normal | Refresh interval: 1s | Transmission type: Unicast port (AUTO) | Unicast port(Image): 32034 (1024-50000) | Unicast port(Audio): 33034 (1024-50000) | Multicast address: 239.192.0.23 | Multicast port: 37004 (1024-50000) | Multicast TTL/HOPLimit: 16 (1-254)

● Initial display settings for "Live" page

Set initial display settings for the Live screen [Live].

Stream

Select the type of images to display in the Live screen [Live].

Setting value:

H.264(1)	Windows	Display videos (H.264(1)).
H.264(2)	Windows	Display videos (H.264(2)).
H.264(3)	Windows	Display videos (H.264(3)).
H.264(4)	Windows	Display videos (H.264(4)).
JPEG(1)		Display still images (JPEG(1))
JPEG(2)		Display still images (JPEG(2))
JPEG(3)		Display still images (JPEG(3))

Factory settings: H264(1)

Refresh interval (JPEG)

Select the frame rate for JPEG images.

Setting value:

For 59.94Hz:

1fps/2fps/3fps/5fps/6fps*1 /10fps*1 /15fps*1 /30fps*1

For 50Hz:

1fps/2fps/5fps/10fps*1 /12.5fps*1 /25fps*1

Factory settings: 5fps

*1 When [H.264 transmission] is set to [On], the frame rate may be slower than the specified value in some cases.

<NOTE>

- The frame rate may be slower depending on the network environment, resolution, image quality, access volume, etc.
- If images are not transmitted at the specified frame rate, lowering the resolution or image quality may result in transmissions closer to the specified value.

Image quality (JPEG)

When displaying JPEG images in the Live screen, set the quality of the first image that appears to [Quality1] or [Quality2].

Setting value:

Quality1	Image quality 1
Quality2	Image quality 2

Factory settings: Quality1

● JPEG

Sets the image resolution, "Quality 1", "Quality 2" and so on for [JPEG(1)], [JPEG(2)] and [JPEG(3)]. For details on settings for H.264 images, see "H.264(1) • H.264(2) • H.264(3) • H.264(4)" (→ page 73).

<NOTE>

- Different resolutions must be selected for [JPEG(1)] to [JPEG(3)]. The same resolution cannot be selected for separate JPEG images.

JPEG transmission

Sets whether to transmit the JPEG images to "On" or "Off."

Setting value:

On	JPEG images are transmitted.
Off	JPEG images are not transmitted.

Factory settings: On

<NOTE>

- When [JPEG(1)] is set to [Off], the image captured with the snapshot button will be black.
- When [JPEG(1)], [JPEG(2)] or [JPEG(3)] is set to [Off], the multi screen may not display. Set all to [On] to use the multi screen.

Image capture size

Select from the following resolutions for the images to be displayed when displaying JPEG images.

Setting value:

1920x1080/1280x720/640x360/320x180/160x90

Factory settings:

JPEG(1): 1920x1080

JPEG(2): 640x360

JPEG(3): 320x180

Image quality

Specify the JPEG image quality (2 types) for each resolution.

Setting value:

0 Super fine / 1 Fine / 2 / 3 / 4 / 5 Normal / 6 / 7 / 8 / 9 Low

Factory settings:

Image quality 1: 5 Normal

Image quality 2: 8

● H.264(1) • H.264(2) • H.264(3) • H.264(4) Windows

Specify the [Max bit rate (per client)], [Image capture size], [Image quality], and other settings for H.264 images.

For details on setting the JPEG images, see "JPEG" (→ page 73).

H.264 transmission

Whether to transmit the H.264 images is set here using On or Off.

Setting value:

On	H.264 images are transmitted.
Off	H.264 images are not transmitted.

Factory settings: On

<NOTE>

- When [On] has been selected as the [H.264 transmission] setting, both H.264 images and JPEG images can be displayed on the live screen [Live].
- When [On] has been selected as the [H.264 transmission] setting, the JPEG image refresh interval may become slower.

Internet mode (over HTTP)

This setting is selected when transmitting H.264 images over the Internet.

H.264 images can be transmitted using the same broadband router settings as when transmitting JPEG images.

Setting value:

On	The H.264 images and audio are transmitted using the HTTP port. For details on setting the HTTP port number, refer to page 90.
Off	The H.264 images and audio are transmitted using the UDP port.

Factory settings: Off

<NOTE>

- When [On] is set, only [Unicast port (AUTO)] can be selected as the [Transmission type] setting.
- When [On] is set, it takes a few seconds before the H.264 images are displayed.
- When this is set to [On], H.264 images may not appear depending on the number of users accessing the unit at the same time and whether audio data exists.
- When this is set to [On], access will be limited to IPv4.

Image capture size

Select the resolution for H.264 images.

Selectable options will vary depending on the selected resolution setting.

Setting value:

H264(1)	1920x1080 1280x720
H264(2)	1920x1080 1280x720 640x360 320x180 160x90
H264(3)	1280x720 640x360 320x180 160x90
H264(4)	1280x720 640x360 320x180 160x90

Factory settings:

H.264(1): 1920x1080

H.264(2): 640x360

H.264(3): 320x180

H.264(4): 160x90

Web screen configurations (continued)

Transmission priority

Set the transmission mode for H.264 images.

Setting value:

Constant bit rate	Transmits H.264 images at the bit rate specified in [Max bit rate (per client)].
Frame rate	Transmit H.264 images at the frame rate specified in [Frame rate].
Best effort	Transmit H.264 images at a variable bit rate between the maximum and minimum specified in [Max bit rate (per client)], according to the network bandwidth.
Advanced VBR	Transmit H.264 images at the frame rate specified in [Frame rate]. Images will be transmitted so that the average transmission volume during the duration specified in [Control time period] will be the bit rate specified in [Max bit rate (per client)].

Factory settings: Frame rate

<NOTE>

- When [Transmission priority] is set to [Frame rate] or [Advanced VBR], the number of users that can connect may decrease.

Frame rate

Set the frame rate for H.264 images.

Setting value:

For 59.94Hz:

5fps*¹ / 15fps*¹ / 30fps*¹ / 60fps*¹

For 50Hz:

5fps*¹ / 12.5fps*¹ / 25fps*¹ / 50fps*¹

Factory settings:

For 59.94Hz: 30fps

For 50Hz: 25fps

- *¹ The [Frame rate] is limited by the [Max bit rate (per client)] setting. The actual frame rate may be lower than the specified value.

<NOTE>

- This setting is only enabled when [Transmission priority] is set to [Frame rate] or [Advanced VBR].
- [H.264(1)] is fixed at 60 fps (for 59.94 Hz) and 50 fps (for 50 Hz). 60 fps (for 59.94 Hz) and 50 fps (for 50 Hz) cannot be selected for [H.264(2)] to [H.264(4)].

Burst tolerance level

Select how much more than the [Max bit rate (per client)] value to allow for the H.264 bit rate.

Setting value:

High / Middle /Low

Factory settings: Low

<NOTE>

- This setting is only enabled when [Transmission priority] is set to [Advanced VBR].

Control time period

Select the duration for which the H.264 bit rate will be controlled. Images will be transmitted so that the average transmission volume during the duration specified will be the bit rate specified in [Max bit rate (per client)].

Setting value:

1h	1 hour
6h	6 hours
24h	1 day (24 hours)
1 week	1 week

Factory settings: 24h

<NOTE>

- This setting is only enabled when [Transmission priority] is set to [Advanced VBR].

Max bit rate (per client)

Specify the H.264 bit rate per client.

When [Transmission priority] is set to [Best effort], specify the maximum and minimum bit rate.

Setting value:

64kbps/128kbps *¹ /256kbps *¹ /384kbps *¹ /512kbps *¹ / 768kbps *¹ /1024kbps *¹ /1536kbps *¹ /2048kbps *¹ /3072kbps *¹ / 4096kbps *¹ /6144kbps *¹ /8192kbps *¹ /10240kbps *¹ / 12288kbps *¹ /14336kbps *¹ /16384kbps *¹ /20480kbps *¹ / 24576kbps *¹

Factory settings:

H.264(1): 4096kbps

H.264(2): 1536kbps

H.264(3): 1024kbps

H.264(4): 512kbps

The range of H.264 bit rates that can be specified varies depending on the resolution.

- 160 × 90: 64kbps to 2048kbps
- 320 × 180, 640 × 360: 64kbps to 4096kbps
- 1280 × 720: 256kbps to 8192kbps
- 1920 × 1080: 512kbps to 14336kbps
- 1920 × 1080 (60fps), 1280 × 720 (60fps): 1024kbps to 24576kbps

- *¹ The H.264 bit rate is limited by the [Bandwidth control (bit rate)] (→ page 90) setting under the [Network] tab of the network setup screen [Network]. The actual bit rate may be lower than the specified value.

Image quality

Select the image quality for H.264 images.

Setting value:

Low(Motion priority) / Normal / Fine(Image quality priority)

Factory settings: Normal

<NOTE>

- This setting is only enabled when [Transmission priority] (→ page 74) is set to [Constant bit rate] or [Best effort].

Refresh interval

Select the refresh interval for H.264 images (I-frame interval: 0.2 to 5 seconds).

If errors occur frequently in the network environment, decreasing the refresh interval will reduce image distortions.

However, the frame rate may decrease.

Setting value:

For 59.94Hz:

0.2s / 0.25s / 0.33s / 0.5s / 1s / 2s / 3s / 4s / 5s

For 50Hz:

0.2s / 0.5s / 1s / 2s / 3s / 4s / 5s

Factory settings: 1s

Transmission type

Select the transmission format for H.264 images.

Setting value:

Unicast port (AUTO)	Up to 14 users can access a single camera at the same time. [Unicast port1 (Image)] and [Unicast port2 (Audio)] will be configured automatically when images and audio are sent from the camera. We recommend selecting the [Unicast port (AUTO)] setting when the port number transmitting the H.264 images does not need to be fixed (e.g., during use within a network).
Unicast port (MANUAL)	Up to 14 users can access a single camera at the same time. [Unicast port1 (Image)] and [Unicast port2 (Audio)] must be configured manually when images and audio are sent from the camera. When transmitting H.264 images via the Internet, configure a fixed transmission port for the broadband router (hereafter referred to as "router") (→ page 89). For details, refer to the operating instructions for the router.
Multicast port	An unlimited number of users can access a single camera at the same time. When transmitting H.264 images via multicast, enter the [Multicast address], [Multicast port], and [Multicast TTL/HOPLimit].

Factory settings: Unicast port (AUTO)

<NOTE>

- For details on the maximum number for simultaneous access, see (→ page 64).

Unicast port1 (Image) *1

Enter the unicast port number (used when sending images from the unit).

Usable port number range: 1024 to 50000

- Only even numbers can be specified.
- The port number cannot be set to 10670.

Factory settings:

H.264(1): 32004
H.264(2): 32014
H.264(3): 32024
H.264(4): 32034

*1 The unicast port number must be configured when [Transmission type] is set to [Unicast port (MANUAL)].

Unicast port2 (Audio)*1

Usable port number range: 1024 to 50000

- Only even numbers can be specified.
- The port number cannot be set to 10670.

Factory settings:

H.264(1): 33004
H.264(2): 33014
H.264(3): 33024
H.264(4): 33034

*1 The unicast port number must be configured when [Transmission type] is set to [Unicast port (MANUAL)].

Multicast address*2

Enter the multicast IP address.

Images and audio will be sent to the specified IP address.

Usable values:

IPv4: 224.0.0.0 to 239.255.255.255
IPv6: Multicast address starting with FF.

Factory settings:

H.264(1): 239.192.0.20
H.264(2): 239.192.0.21
H.264(3): 239.192.0.22
H.264(4): 239.192.0.23

<NOTE>

- Verify usable multicast IP addresses before entering this setting.

Multicast port*2

Enter the multicast port number (used when sending images from the unit).

Usable port number range: 1024 to 50000

- Only even numbers can be specified.
- The port number cannot be set to 10670.

Factory settings: 37004

<NOTE>

- When sending audio from the unit, a port number with "1000" added to the multicast port number will be used.

Multicast TTL/HOP Limit*2

Enter the TTL/HOPLimit value for multicast.

Usable values: 1 to 254

Factory settings: 16

<NOTE>

- When transmitting H.264 images via the Internet, transmitted images may not appear depending on proxy server settings, firewall settings, etc. In such cases, consult your network administrator.
- When displaying multicast images on a personal computer with multiple LAN cards installed, disable the LAN cards that are not used for reception.

■ When HDI|HX is activated

- The [Parameter Setting] function has been added to the IP video setting tab [Video over IP], allowing you to select a setting for NDI|HX. (→ page 73)

The function supports H.264/IP transmission using NDI|HX.

- When you set Parameter to [NDI|HX], the settings of the items below will change.

IP video settings tab [Video over IP] (→ pages 72 to 75)

[JPEG(2)], [JPEG(3)] [H.264(3)], and [H.264(4)] cannot be selected.

- H.264(1), H.264(2)**

Internet mode (over HTTP)

The setting will be set to [Off].

Image capture size

The following settings will be available.

H.264(1)	1920×1080
H.264(2)	640×360

Transmission priority

The setting will be set to [Frame rate].

Max bit rate (per client)

The following settings will be available.

H.264(1)	10240kbps
H.264(2)	1024kbps

- This product is compatible with NDI|HX technology of NewTek, Inc.

■ Audio [Audio]

Configure audio settings.

<NOTE>

- Images and audio are not synchronized. Therefore, images and audio may be slightly out of sync.
- The audio may skip depending on the network environment.



Audio

Set the communication mode used to transmit audio data between the unit and the personal computer.

Setting value:

Off	Do not transmit audio data between the unit and the personal computer. All settings and controls related to audio will be disabled.
On	The personal computer receives audio data from the unit. This allows images to be viewed on the personal computer with audio. Images and audio are not synchronized.

Factory settings: Off

Audio encoding format

Select the audio compression format.

Setting value: G.726 / AAC-LC (High quality)

Factory settings: AAC-LC (High quality)

Audio bit rate

Set the bit rate for transmitting audio.

Setting value:

G.726

16kbps / 32kbps

AAC-LC (High quality)

64kbps / 96kbps / 128kbps

Factory settings: 128kbps

Mic input volume

Set the volume of the audio from the unit when listening to it on the personal computer.

Setting value:

Mic High	Set the volume to high. Use this when audio is input to the camera via a microphone.
Mic Middle	Set the volume to medium. Use this when audio is input to the camera via a microphone.
Mic Low	Set the volume to low. Use this when audio is input to the camera via a microphone.
Line High	Set the volume to high. Use this when audio is input to the camera via line input.
Line Middle	Set the volume to medium. Use this when audio is input to the camera via line input.
Line Low	Set the volume to low. Use this when audio is input to the camera via line input.

Factory settings: Line Middle

Mic input interval

Selects the mic input interval.

Setting value: 20msec / 40msec / 80msec / 160msec

Factory settings: 40msec

<NOTE>

- The delay time will shorten if a shorter input interval is set. Setting a longer input interval will increase the delay time, but you will be able to reduce instances of audio cutting in and out. Set the value based on your network environment.
- This setting is available only when the [Audio encoding format] is set to [G.726].

Plugin Power

Turn plug-in power on/off.

Off	Set plug-in power to on.
On	Set plug-in power to off.

<NOTE>

- This is only enabled when [Mic input volume] is set to [Mic High], [Mic Middle], and [Mic Low].

■ Image adjust / preset position screen

[Image/Position]

Display the image quality adjustment / preset position screen.

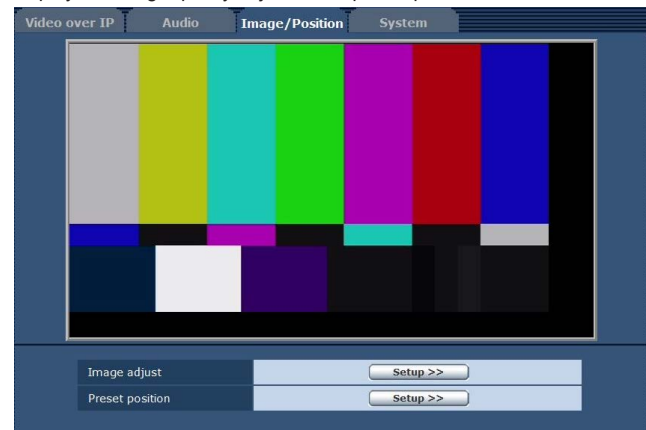

Image adjust

When you click the [Setup] button, the image adjust screen [Image adjust] appears. (→ page 77)

Preset position

When you click the [Setup] button, the preset position screen [Preset position] appears. (→ page 81)

Web screen configurations (continued)

● Image adjust screen [Image adjust]

Adjust the image quality.

To display the Image adjust screen, click the [Setup] button for [Image adjust] at the bottom of the Image/Position screen.

The settings in this screen (with the exception of [Scene]) are applied immediately.

Scene

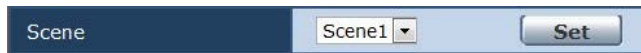

Switch the shooting mode depending on the shooting environment. Select a shooting mode based on the shooting conditions or preference.

Select a shooting mode from the pull-down menu, and click the [Set] button to switch to the selected mode.

Setting value:

Scene1	Modes that allow you to adjust detailed settings manually for various shooting conditions and preferences.
Scene2	
Scene3	
Scene4	

Brightness

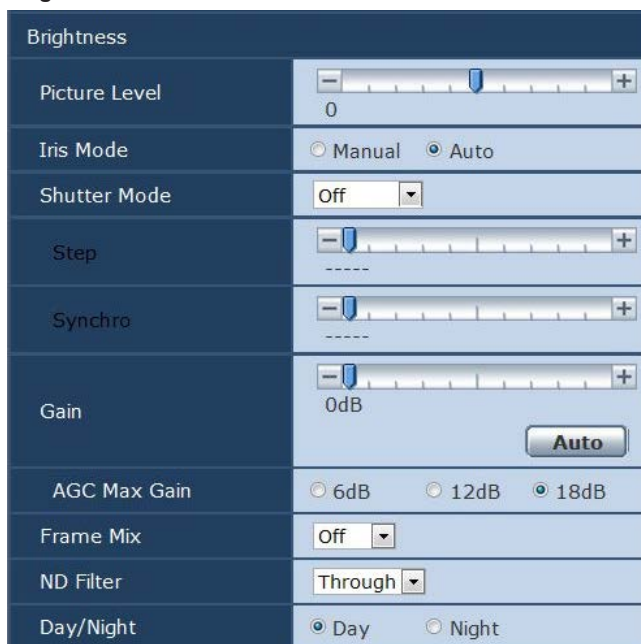

Picture Level

Set the target picture level for auto exposure correction.

This is enabled when any one of the following auto exposure correction functions is set to [Auto] or [ELC].

- When [Iris Mode] is set to [Auto]
- When [Shutter Mode] is set to [ELC]
- When [Gain] is set to [Auto]

Setting range: -50 to +50

Factory settings: 0

Iris Mode

Select whether to adjust the iris automatically or manually.

Setting value:

Manual	Adjust the iris manually.
Auto	Exposure correction is performed automatically to match the target level specified in [Picture Level].

<NOTE>

- [Iris Mode] cannot be set to [Auto] when [Frame Mix] is set to [18dB] or [24dB].

Shutter Mode

Select for camera shutter speed.

When a higher shutter speed is selected, fast-moving subjects do not become blurred easily but the images will be darker.

Setting value:

Off	The shutter is set to OFF.
Step	The step shutter is set (the steps can be changed).
Synchro	The synchro shutter is set (the setting can be changed continuously).
ELC	The electronic shutter is controlled and the light quantity is adjusted automatically.

Factory settings: Off

The shutter speeds that can be set are listed below.

When 59.94 Hz has been set as the unit's frequency :

	When [Step] is selected as the [Shutter Mode]	When [Synchro] is selected as the [Shutter Mode]
For 59.94p/59.94i	1/100, 1/120, 1/250, 1/500, 1/1000, 1/2000, 1/4000, 1/10000	60.15Hz to 642.21Hz (255 steps)
For 29.97p	1/30, 1/60, 1/120, 1/250, 1/500, 1/1000, 1/2000, 1/4000, 1/10000	
For 23.98p	1/24, 1/60, 1/120, 1/250, 1/500, 1/1000, 1/2000, 1/4000, 1/10000	

When 50 Hz has been set as the unit's frequency :

	When [Step] is selected as the [Shutter Mode]	When [Synchro] is selected as the [Shutter Mode]
For 50p/ 50i	1/60, 1/120, 1/250, 1/500, 1/1000, 1/2000, 1/4000, 1/10000	50.15Hz to 535.71Hz (255 steps)
For 25p	1/25, 1/60, 1/120, 1/250, 1/500, 1/1000, 1/2000, 1/4000, 1/10000	

<NOTE>

- When [Shutter Mode] is set to [OFF] in 29.97P, 23.98P, or 25P mode, the shutter speed is set to [1/50].

Gain

The image gain is adjusted here.

In locations which are too dark, adjust the gain upward; conversely, in locations which are too bright, adjust it downward.

Setting range: Auto, 0dB to 36dB

When [Auto] is set, the light quantity is adjusted automatically.

The noise increases when the gain is increased.

Factory settings: 0dB

<NOTE>

- [Gain] cannot be set to [Auto] when [Frame Mix] is set to [18dB] or [24dB].

AGC Max Gain

When [Auto] is selected as the [Gain] setting, the maximum gain-up amount can be set.

Setting value: 6dB / 12dB / 18dB

Factory settings: 18dB

Web screen configurations (continued)

Frame Mix

Select for frame addition (gain-up using sensor storage) amount.
When frame addition is performed, it will appear as if the images are missing some frames.

Setting value: Off / 6dB / 12dB / 18dB / 24dB

Factory settings: Off

- This cannot be configured when the format is 1080/29.97p, 1080/23.98p, 1080/29.97PsF, 1080/23.98PsF, 1080/25p, or 1080/25PsF.
- [Frame Mix] cannot be set to [18dB] or [24dB] when [Iris Mode], [Gain], or [Focus Mode] is set to [Auto]. (When setting [Frame Mix] to [18dB] or [24dB], set [Iris Mode] and [Focus Mode] to [Manual] and set [Gain] to any setting other than [Auto].)

<NOTE>

- Under discharge tube illumination, such as fluorescent and mercury-vapor lights, the brightness may change synchronously, colors may change, and horizontal stripes may flow up and down the image. In such cases, we recommend setting the electronic shutter speed to 1/100 in regions with 50 Hz power supply frequency, and to OFF in regions with 60 Hz power supply frequency.

ND Filter

Set the transmittance of the lens' built-in ND (neutral density) filter.

Setting value:

Through	Do not set ND filter.
1/8	Set ND filter transmittance to 1/8.
1/64	Set ND filter transmittance to 1/64.

Factory settings: Through

Day/Night

Switch between standard shooting and night-vision shooting (shooting with infrared light).

Setting value:

Day	Standard shooting (day mode)
Night	Night-vision shooting (night mode)

Factory settings: Day

<NOTE>

- The iris will be forcibly opened.
- White balance adjustment is not possible in night mode.
- ND filter switching is not possible in night mode.
- Pedestal adjustment is not possible in night mode.

Picture

Picture	
Chroma Level	<input type="range"/> 0%
White Balance Mode	AWB A ▾
AWB	<input type="button" value="Execute"/>
Color Temperature	<input type="range"/> 3200K
R Gain	<input type="range"/> 0
B Gain	<input type="range"/> 0
ABB	<input type="button" value="Execute"/>
Pedestal	<input type="range"/> 0
R Pedestal	<input type="range"/> 0
B Pedestal	<input type="range"/> 0
Detail	<input type="radio"/> Off <input checked="" type="radio"/> On
Master Detail	<input type="range"/> 31
V Detail Level	<input type="range"/> 0
Detail Band	<input type="range"/> 0
Noise Suppress	<input type="range"/> 1
Flesh Tone Noise SUP.	<input type="range"/> 16
Gamma Type	HD ▾
Gamma	<input type="range"/> 0.45
DRS	Off ▾
Knee Mode	<input type="radio"/> Off <input checked="" type="radio"/> Auto <input type="radio"/> Manual
Knee Point	<input type="range"/> 93.00%
Knee Slope	<input type="range"/> 85
White Clip	<input type="radio"/> Off <input checked="" type="radio"/> On
White Clip Level	<input type="range"/> 109%
DNR	<input checked="" type="radio"/> Off <input type="radio"/> Low <input type="radio"/> High
Matrix	
Matrix Type	Normal ▾ <input type="button" value="Setup>>"/>
<input type="button" value="Close"/>	

Chroma Level

Set here the color intensity (chroma level) of the images.

Setting range: OFF, -99% to 40%

Factory settings: 0%

White Balance Mode

Set the white balance mode.

Select the mode when the coloring is not natural because of the nature of the light source or other factors.

If the white color serving as the reference can be recognized, subjects can be shot with natural coloring.

Setting value:

ATW	In this mode, the white balance is compensated for automatically, even if changes occur in the light source or color temperature, by a process of continuous and automatic adjustment.
AWB A AWB B	When [AWB A] or [AWB B] is selected and the white balance is executed, the adjustment results obtained are stored in the memory selected. When [AWB A] or [AWB B] is then selected, the white balance stored in the selected memory can be recalled.
3200K	This is the white balance mode which is ideal when a 3200K halogen light is used as the light source.
5600K	This is the white balance mode which is ideal when 5600K sunlight or fluorescent lighting is used as the light source.
VAR	Specify a color temperature between 2000 K and 15000 K.

Factory settings: AWB A

AWB

This is used to execute automatic white balance (AWB) to set the white balance. For further details, refer to (→ page 32).

Color Temperature

Specify a color temperature between 2,000 K and 15,000 K.

This is enabled when [White Balance Mode] is set to [VAR].

Setting range: 2000K to 15000K

Factory settings: 3200K

R Gain

This enables the R gain to be adjusted.

This is enabled when [White Balance Mode] is set to [AWB A], [AWB B], or [VAR].

Setting range: -150 to +150

Factory settings: 0

B Gain

This enables the B gain to be adjusted.

Its setting takes effect when [AWB A], [AWB B] or [Var] has been selected as the [White Balance Mode] setting.

Setting range: -150 to +150

Factory settings: 0

ABB

This is used to execute automatic black balance (ABB) to set the black balance. For further details, refer to (→ page 34).

Pedestal

This item is used to adjust the black level (adjust the pedestal).

These parts become darker when a negative setting is selected and, conversely, lighter when a positive setting is selected.

Setting range: -150 to +150

Factory settings: 0

R Pedestal

This enables the R pedestal to be adjusted.

The same R pedestal setting is used for all the scenes.

Setting range: -100 to +100

Factory settings: 0

B Pedestal

This enables the B pedestal to be adjusted.

The same B pedestal setting is used for all the scenes.

Setting range: -100 to +100

Factory settings: 0

Detail

Turn outline (i.e., image sharpness) adjustment on/off.

Setting value: Off / On

Factory settings: On

Master Detail

Perform outline (i.e., image sharpness) adjustment.

Higher values result in increased sharpness in outlines.

Setting range: 0 to 62

Factory settings: 0

V Detail Level

Adjust the vertical contour correction level.

Setting range: -7 to +7

Factory settings: 0

Detail Band

This is selected to set the boost frequency for Detail.

Setting range: -7 (Low frequency) to +7 (High frequency)

Factory settings: 0

Higher frequencies result in a more detailed effect applied to the subject.

Noise Suppress

This is selected to reduce the screen noise which is generated by the detail effect.

The higher the settings, the more the noise is reduced.

Setting range: 0 to 60

Factory settings: 1

Flesh Tone Noise SUP

This function is selected to make the skin of the subjects to be shot appear to be smoother and more attractive.

When "High" is selected, the effect is enhanced.

Setting range: 0 to 31

Factory settings: 16

Gamma Type

Select the type of gamma curve.

Setting value:

HD	HD (High Definition) video gamma characteristic.
SD	Gain in dark areas is higher than in HD gamma.
FILMLIKE1	Characteristic capable of reproducing better gradation in highlights than HD gamma.
FILMLIKE2	Characteristic capable of reproducing better gradation in highlights than [FILMLIKE1].
FILMLIKE3	Characteristic capable of reproducing better gradation in highlights than [FILMLIKE2].

Factory settings: HD

Gamma

Adjust the gamma correction level.

Specifying smaller values results in a gentler gamma curve for the slope of low-brightness areas and sharper contrast.

Specifying larger values results in an expanded gradient for dark areas and produces brighter images. The gamma curve for low-brightness areas will be steeper, and contrast will be softer.

Setting range: 0.30 to 0.75

Factory settings: 0.45

DRS

Set the DRS function which performs correction when video with high light/dark contrast is displayed.

You can select from a [Low], [Mid], or [High] effect level.

Depending on the scene, noise may worsen.

Setting value: Off / Low / Mid / High

Factory settings: Off

<NOTE>

- When DRS is enabled, knee settings ([Knee Mode], [Knee Point], [Knee Slope]) and [Gamma Type] and [Gamma] settings are disabled.

Knee Mode

Set the operating mode for gradation compression (knee).

Setting value:

Off	Turn the knee function off.
Auto	Enable the knee function, and set the knee point and knee slope automatically.
Manual	Enable the knee function, and set the knee point and knee slope manually.

Factory settings: Auto

Knee Point

Set the compression level (knee point) position for high-brightness video signals.

This is only enabled when [Knee Mode] is set to [Manual].

Setting range: 70.0% to 107.0%

Factory settings: 93.0%

Knee Slope

Set the knee slope.

This is only enabled when [Knee Mode] is set to [Manual].

Setting range: 0 to 99

Factory settings: 85

<NOTE>

- When [DRS] is enabled, the knee setting is disabled.

White Clip

Turn the white clip function off/on.

Setting value: Off / On

Factory settings: On

White Clip Level

Set the white clip level.

This is only enabled when [White Clip] is set to [On].

Setting range: 90% to 109%

Factory settings: 109%

<NOTE>

- When [Knee Mode] is set to [Auto] and the white clip value is changed, the knee value will also change.

DNR

Set the digital noise reduction level for outputting bright, clear images without noise, even at night and low-light conditions.

Selecting [Low] or [High] removes noise.

However, image lag may increase.

Setting value: Off / Low / High

Factory settings: Off

● Matrix settings screen [Matrix Settings]

Set matrix settings.

To display the Matrix Settings screen, click the [Setup] button for [Matrix Type] at the bottom of the Image/Position screen.

These settings can only be configured when [Matrix Type] is set to [User].

The settings in this screen are applied immediately.



Web screen configurations (continued)

Matrix Type

Select the type of color matrix.

Setting value:

Normal	Load preset color matrix data, and perform saturation and hue adjustment.
EBU	
NTSC	
User	Adjust the [Linear Matrix] and [Color Correction] values.

Factory settings: Normal

Linear Matrix

This can be set when [User] has been selected as the [Matrix Type] setting.

Setting value:

R-G	Adjust the color to between -63 to +63 for each axis direction.
R-B	
G-R	
G-B	
B-R	
B-G	

Color Correction

This can be set when [User] has been selected as the [Matrix Type] setting.

Adjust the saturation and hue.

Saturation

Adjust the saturation for each color.

Setting range: -63 to +63

Phase

Adjust the hue for each color.

Setting range: -63 to +63

B_Mg	Color between blue and magenta
Mg	Magenta
Mg_R	Color between magenta and red
Mg_R_R	Color with a 1:3 magenta to red ratio
R	Red
R_R_YI	Color with a 3:1 red to yellow ratio
R_YI	Color between red and yellow
R_YI_YI	Color with a 1:3 red to yellow ratio
YI	Yellow
YI_G	Color between yellow and green
G	Green
G_Cy	Color between green and cyan
Cy	Cyan
Cy_B	Color between cyan and blue
B	Blue

● Preset position screen [Preset position]

Perform operations and adjustments related to preset positions.

To display the Preset position screen, click the [Setup] button for [Preset position] in the image adjust / preset position screen [Image/Position]. The settings in this screen (with the exception of [Preset]) are applied immediately.

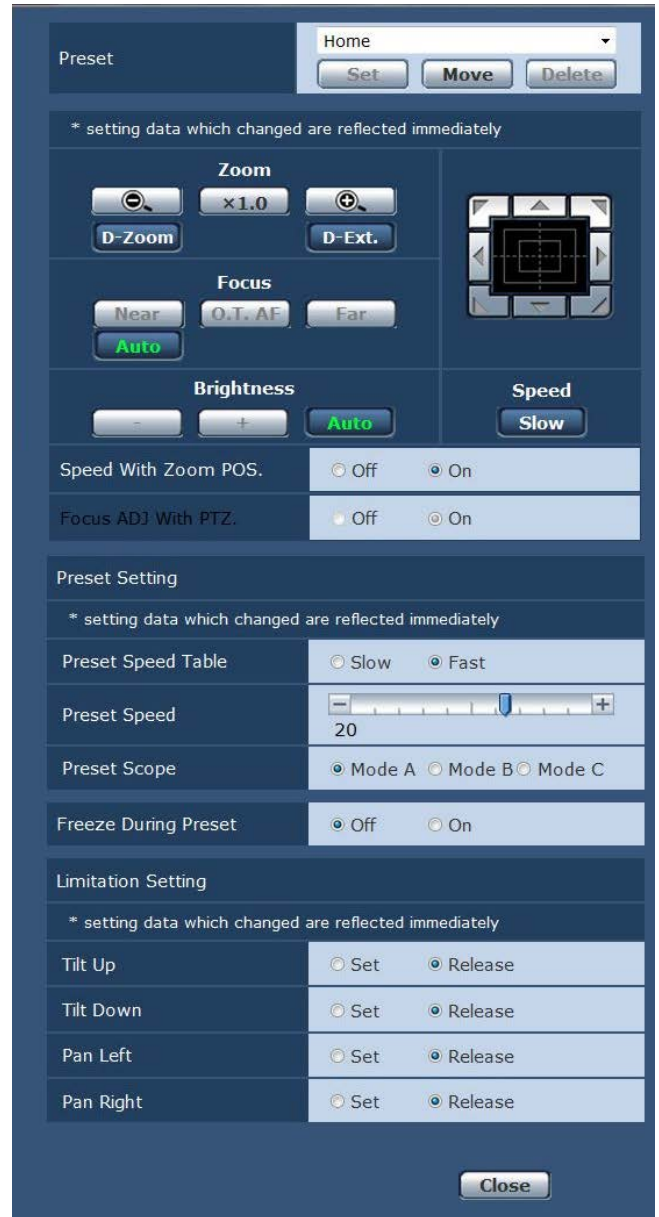





Preset





Home	
This selects the preset position to be operated from the pull-down menu.	
Set (Set)	This is used to register the current status in the preset position now selected on the pull-down menu. It does not function if [Home] has been selected on the pull-down menu.
Move (Move)	The camera direction moves to the preset position which is now selected on the pull-down menu. The settings that are reproduced at this position are the settings which were established on the [Preset Scope] menu (→ page 56, page 82, page 84). The camera direction moves to the home position if [Home] has been selected on the pull-down menu. In such cases, the image output during movement to the home position will not freeze, regardless of the [Freeze During Preset] setting.
Delete (Delete)	This is used to delete the preset position setting which is currently being selected. It does not function if [Home] has been selected on the pull-down menu.

Web screen configurations (continued)



Zoom

	Use this to adjust the zoom (magnification) in the Wide direction.
	Use this to adjust the zoom (magnification) to 1.0x.
	Use this to adjust the zoom (magnification) in the Tele direction.
	Use this to enable or disable the digital zoom.
	Enable or disable the digital extender. This operates only when digital zoom is disabled.

Focus

	Use this to adjust the focus in the Near direction. It does not work during automatic adjustments.
	When this is pressed while the focus is being adjusted manually, the focus will be temporarily adjusted automatically. It does not work during automatic adjustments.
	Use this to adjust the focus in the Far direction. It does not work during automatic adjustments.
	Use this to switch between auto and manual focusing.

Brightness

	Use this to make the image darker. It does not work during automatic adjustments.
	Use this to make the image lighter. It does not work during automatic adjustments.
	Use this to switch the picture brightness adjustment between auto and manual.

Control pad and its buttons

	<p>To adjust the image in the horizontal or vertical direction (panning or tilting), left-click the pad and the buttons.</p> <p>The more the outside of the pad is clicked, the faster the camera operates.</p> <p>Adjustment is also possible by dragging the mouse.</p> <p>Right-click the pad to initiate zooming and focusing.</p> <p>When the top half of the pad is clicked in the up or down direction, the zoom (magnification) is adjusted in the Tele direction; conversely, when the bottom half of the pad is clicked, the zoom is adjusted in the Wide direction.</p> <p>When the left half of the pad is clicked in the left or right direction, the focus is adjusted in the Near direction; conversely when the right half of the pad is clicked, the focus is adjusted in the Far direction. The zooming can also be adjusted by operating the mouse wheel.</p>
---	--

<NOTE>

- When the mouse is used for dragging and dropping from the control pad area to a position outside this area, the panning, tilting and other operations will not stop. In a case like this, click the control pad area to stop these operations.

Speed

	Use this to select the speed at which the pan, tilt, zoom, focus, and brightness operations are to be performed.
---	--

Speed With Zoom POS.

"Off" or "On" is set here for the function used to adjust the pan-tilt adjustment speed in conjunction with the zoom magnification.

Setting value:

Off	The panning and tilting operations will not become slower in the zoom status.
On	The panning and tilting operations will become slower in the zoom status. This function has no effect during preset operations.

Focus ADJ With PTZ.

"Off" or "On" is set here for the function which compensates for out-of-focusing when it occurs during panning, tilting or zooming operations.

Setting value:

Off	Out-of-focusing is not compensated.
On	Out-of-focusing is compensated.

When [Off] is set, adjust the focus as required after zooming or set the focus to the auto mode.

This item can be selected only when [Manual] has been selected as the [Focus Mode] setting.

Preset Setting

Preset Speed Table

Set the preset speed table (Slow, Fast).

During preset playback, presets are performed at [Preset Speed] (1 to 30) values that are based on the table set here.

Setting value:

Slow	Set the preset speed table to slow.
Fast	Set the preset speed table to fast.

Preset Speed

Set the pan/tilt movement speed used when recalling camera orientation information registered to the preset memory (30 steps).

Setting range: 1 to 30

<NOTE>

- When you set large [Preset Speed] values, the image may sway when the movement stops.
- When [Preset Speed Table] is set to [Fast], [Preset Speed] values equivalent to the AW-HE120 will be applied.

Preset Scope

Selected here are the setting items to be recalled when the contents of the preset memory are regenerated.

Setting value:

Mode A	Pan, Tilt, Zoom (including digital zoom), Focus, Iris, Gain, white balance adjustment value
Mode B	Pan, Tilt, Zoom (including digital zoom), Focus, Iris
Mode C	Pan, Tilt, Zoom (including digital zoom), Focus

Freeze During Preset

Turn the function for freezing images during preset playback off/on.

When this is set to [On], preset playback is performed with a still of the image immediately preceding the start of preset playback being output. The image freeze is released when preset playback is finished.

Setting value:

Off	Do not freeze images during preset playback.
On	Freeze images during preset playback.

Limitation Setting

This establishes the up, down, left and right limit settings of the pan-tilt head.

First, move the pan-tilt head to the position where the limit is to be set, and press the corresponding button below to set the direction (up, down, left or right) in which the limit is to be set.

After each setting has been selected, press the Set button to enter the setting.

Tilt Up	Use this to save the current position as the upward limit.
Tilt Down	Use this to save the current position as the downward limit.
Pan Left	Use this to save the current position as the leftward limit.
Pan Right	Use this to save the current position as the rightward limit.
Set/Release	Use this to enable or disable the limit setting in each direction.

System screen [System]

This menu has items that relate to the genlock phase adjustment and camera's output image settings.

The screenshot shows the 'System' configuration page with the following settings:

- Genlock**: * setting data which changed are reflected immediately. Horizontal Phase: 0.
- Output 1/3**: Format: 1080/59.94i.
- Output 2/3**: Frequency: 59.94Hz.
- Output 3/3**: Down CONV. Mode: Squeeze. Color Bars Setup: Off.
- Others**:
 - Install Position: Desktop
 - Smart Picture Flip: Off
 - Flip Detect Angle: 0
 - Preset Speed Table: Fast
 - Preset Scope: Mode A
 - Preset D-Extender: Off
 - Freeze During Preset: Off
 - Speed With Zoom POS.: On
 - Focus Mode: Auto
 - Focus ADJ With PTZ.: On
 - Digital Zoom: Disable
 - Max Digital Zoom: 0
 - Digital Extender: Off
 - OIS: Off
 - Tally: Enable
 - Tally Brightness: Low
 - Status Lamp: Enable
 - OSD Mix:
 - SDI Out: On
 - HDMI Out: On
 - Video Out: On
 - IP: On
 - OSD Off With Tally: Off
 - OSD Status: Off
- Protocol**: Model Select: SEVIHD1.

● Genlock

This item's setting is reflected immediately.

Horizontal Phase

This is used to adjust the horizontal phase during genlock.

Setting range: -206 to +49

Factory settings: 0

<NOTE>

- The horizontal phases of the HD and SD signals cannot be adjusted separately.
- Neither is it possible to adjust the chroma phase of the VIDEO OUT signals. The free run setting is used.

Web screen configurations (continued)

● Output 1/3

This item's setting is reflected when the [Set] button is pressed.

Format

The video format is changed on this screen.

For [480/59.94p(i)] and [576/50p(i)], P signals are output for HDMI, while I signals are output for SDI and video outputs.

Setting value:

For 59.94Hz:

1080/59.94p, 1080/29.97p, 1080/23.98p, 1080/59.94i,
1080/29.97PsF, 1080/23.98PsF, 720/59.94p, 480/59.94p(i)

For 50Hz:

1080/50p, 1080/25p, 1080/50i, 180/25PsF, 720/50p, 576/50p(i)

Factory settings: 1080/59.94i (AW-HE130WP/AW-HE130KP)
1080/50i (AW-HE130WE/AW-HE130KE)

<NOTE>

- When you switch from an HD format to an SD format or vice versa, the unit automatically restarts after the Format Set screen appears.

● Output 2/3

This item's setting is reflected when the [Set] button is pressed.

Frequency

This item is selected to switch the frame frequency.

Setting value:

59.94Hz / 50Hz

- When the frequency is switched, [Format] is set as follows.

59.94Hz		50Hz
1080/59.94p	↔	1080/50p
1080/29.97p	↔	1080/25p
1080/23.98p	→	1080/25p
1080/59.94i	↔	1080/50i
1080/29.97PsF	↔	1080/25PsF
1080/23.98PsF	→	1080/25PsF
720/59.94p	↔	720/50p
480/59.94p(i)	↔	576/50p(i)

Factory settings: 59.94Hz (AW-HE130WP/AW-HE130KP)
50Hz (AW-HE130WE/AW-HE130KE)

● Output 3/3

This item's setting is reflected when the [Set] button is pressed.

Down CONV. Mode

The down-conversion mode is selected here.

Setting value:

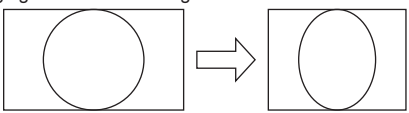
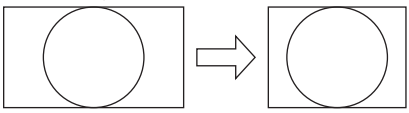
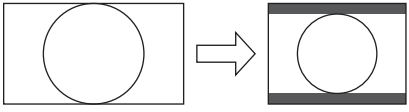
Squeeze	Use this when the aspect ratio of the monitor is 16:9. When the 4:3 aspect ratio has been set for the monitor screen, the images are squeezed horizontally and extended vertically changing the view of the angle. 
SideCut	Use this when the aspect ratio of the monitor is 4:3. With the vertical height serving as the reference, the parts which extend beyond this at the two sides are cropped changing the view of the angle. 
LetterBox	Use this when the aspect ratio of the monitor is 4:3. With the horizontal width serving as the reference, black bands are added at the top and bottom changing the view of the angle. 

Factory settings: Squeeze

Color Bars Setup

This is only enabled when [Frequency] is set to [59.94Hz].

Select the color bar setup level (Off: 0.0IRE, On: 7.5IRE) for the VIDEO OUT signal.

Setting value:

Off	0.0IRE
On	7.5IRE

Factory settings: Off

● Others

This item's setting is reflected when the [Set] button is pressed.

Install Position

"Desktop" or "Hanging" is selected here as the method used to install the unit.

Setting value:

Desktop	Stand-alone installation
Hanging	Suspended installation

Factory settings: Desktop

- When [Hanging] has been selected, the top, bottom, left and right of the images will be reversed, and up/down/left/right control for panning and tilting will also be reversed.

Smart Picture Flip

When this is set to [Auto] and the tilt becomes the angle set for [Flip DetectAngle], the image will be flipped in the vertical direction automatically.

Setting value:

Off	Does not flip the image vertically.
Auto	When the tilt becomes the angle set for [Flip DetectAngle], the image will be flipped in the vertical direction automatically.

Factory settings: Off

Flip Detect Angle

Set the tilt angle at which the image will be flipped in the vertical direction automatically when [Smart Picture Flip] is set to [Auto].

Setting range: 60° to 120°

Factory settings: 90°

Preset Speed Table

Set the preset speed table (Slow, Fast).

During preset playback, presets are performed at [Preset Speed] (1 to 30) values that are based on the table set here.

Setting value: Slow / Fast

Factory settings: Fast

Preset Speed

Set the pan/tilt movement speed used when recalling camera orientation information registered to the preset memory (30 steps).

Setting range: 1 to 30

Factory settings: 20

- When you set large [Preset Speed] values, the image may sway when the movement stops.
- When [Preset Speed Table] is set to [Fast], [Preset Speed] values equivalent to the AW-HE120 will be applied.

Preset Scope

Selected here are the setting items to be recalled when the contents of the preset memory are regenerated.

Setting value:

Mode A	Pan, Tilt, Zoom (including digital zoom), Focus, Iris, Gain, white balance adjustment value
Mode B	Pan, Tilt, Zoom (including digital zoom), Focus, Iris
Mode C	Pan, Tilt, Zoom (including digital zoom), Focus

Factory settings: Mode A

Preset D-Extender

Turns the preset digital extender function off/on.

When set to [On], the digital extender function configuration will be recalled when regenerating the preset memory. When set to [Off], the digital extender function configuration will not be recalled when storing the preset memory.

Setting range: Off / On

Factory settings: Off

Freeze During Preset

Turn the function for freezing images during preset playback off/on.

When this is set to [On], preset playback is performed with a still of the image immediately preceding the start of preset playback being output. The image freeze is released when preset playback is finished.

Setting value: Off / On

Factory settings: Off

Speed With Zoom POS.

"Off" or "On" is set here for the function used to adjust the pan-tilt adjustment speed in conjunction with the zoom magnification.

When [On] is set, the panning and tilting operations will become slower in the zoom status.

This function has no effect during preset operations.

Setting value: Off / On

Factory settings: On

Focus Mode

Select auto or manual mode for the focus adjustment function.

Setting value:

Auto	Always adjust focus automatically.
Manual	Adjust focus manually.

Factory settings: Auto

<NOTE>

- [Focus Mode] cannot be set to [Auto] when [Frame Mix] is set to [18dB] or [24dB].

Focus ADJ With PTZ.

"Off" or "On" is set here for the function which compensates for out-of-focusing when it occurs during panning, tilting or zooming operations. When [Off] is set, adjust the focus as required after zooming or set the focus to the auto mode.

This item can be selected only when [Manual] has been selected as the [Focus Mode] setting.

Setting value:

Off	Out-of-focusing is not compensated.
On	Out-of-focusing is compensated.

Factory settings: Off

Digital Zoom

"Enable" or "Disable" is set here for the digital zoom function.

If zooming is performed toward the Tele end beyond the maximum position when [Enable] has been selected, the digital zoom can be operated continuously. Zooming will stop temporarily at the position where the optical zoom and digital zoom are switched so after it has stopped at this position, proceed with zooming again.

When the setting is changed to "Disable" while already in the digital zoom region, the zoom will automatically move to the maximum position of the optical zoom.

Setting value: Disable / Enable

Factory settings: Disable

The digital zoom is set to off when color bars are displayed during digital zooming.

Max Digital Zoom

Set the maximum digital zoom magnification.

Setting value:

x2 / x3 / x4 / x5 / x6 / x7 / x8 / x9 / x10

Digital Extender

Turn the digital extender function off/on.

When this is set to [On], the digital zoom will be fixed at 1.4x.

When [Digital Zoom] is set to [Enable], [Digital Extender] is disabled.

Setting value: Off / On

Factory settings: Off

OIS

Enable or disable the optical image stabilization (OIS) function.

Setting value: Off/On

Factory settings: Off

<NOTE>

- The optical image stabilization (OIS) function's level of correction is reduced during pan/tilt operations.

Tally

"Enable" or "Disable" is set here for the function which turns on or turns off the tally lamp using the tally control signal.

Setting value: Disable / Enable

Factory settings: Enable

Tally Brightness

Adjust the brightness of the tally LED.

Setting value: Low / Mid / High

Factory settings: Low

<NOTE>

- When this is set to [Low], the LED brightness is equivalent to that of the AW-HE120.

Status Lamp

Sets the status lamp to [Disable] or [Enable].

When you want the status lamp to stay off while this unit is in operation, set to [Disable].

Setting value: Disable / Enable

Factory settings: Enable

<NOTE>

- Even when set to [Disable], the status lamp may light up when this unit is starting up, updating firmware, or trouble is occurring.

OSD Mix

Select whether to turn off/on camera menu, status, and other displays for each output image.

Setting value: Off / On

Factory settings: On

SDI Out

HDMI Out

Video Out

IP

When this is set to [On], the camera menu, status, and other displays for corresponding output image are displayed.

Setting value:

Off	The camera menus and statuses are not displayed on the output pictures targeted by the setting items listed above.
On	The camera menus and statuses are displayed for the output pictures covered by the setting items listed above.

Factory settings: On

<NOTE>

- When this is set to [Off], the camera menu can be displayed for about 1 minute after the unit is turned on.

OSD Off With Tally

On or off the function that turns off camera menu, status, and other displays when tally signals are received via commands or contacts. When the tally signal releases, the camera menu display will return.

Setting value: Off / On

Factory settings: Off

OSD Status

Turn the status display during AWB and ABB on/off.

Setting value: Off / On

Factory settings: Off

Model Select

Set the protocol model for standard serial communication.

Do not select [Reserved1] to [Reserved7].

Appears when the service switch (SW4) at the bottom of the unit is set to ON (standard serial communication).

Setting value:

SEVIHD1 / SBRC300 / SBRCZ330 / Reserved1 to 7

Factory settings: SEVIHD1

Multi screen setup screen [Multi-Screen setup]

The cameras whose images are to be displayed on the multi screen are set here.

Camera title

Input the camera title here. The camera title which has been input is displayed on the multi screen.

- You can enter between 0 to 20 half-size characters.
- The following characters can be displayed.

Half-size numeric characters	0123456789
Half-size alphabetical characters (upper and lower cases)	ABCDEFGHIJKLMNOPQRSTUVWXYZ abcdefghijklmnopqrstuvwxyz
Symbols	!#\$%&'()*+,-./:;<=>?@[^_`{ }~\

Factory settings:

Cam 1: The product number appears.
Cam 2 to Cam 16: blank

<NOTE>

- When a 16-screen multi screen is selected, camera titles may be only partially displayed.
- Multi screen displays are displayed in 4:3 aspect ratio.

IP address

Input here the IP address of the camera whose images are to be displayed on the multi screen or the host name. With one group consisting of 4 cameras, up to four groups of cameras (a total of 16 cameras) can be registered.

Input as follows if the HTTP port number of the camera whose images are to be displayed has been changed.

IPv4 address entry example	192.168.0.10:8080
IPv6 address entry example	[2001:db8:0:0:0:0:1]:8080

Factory settings:

Cam 1: selfcamera
Cam 2 to Cam 16: Not registered

<NOTE>

- HTTPS cannot be used to connect to the camera whose images are to be displayed.
- This unit is configured for cameras for which "selfcamera" is displayed for the IP address or host name.
- When configuring a host name, the DNS settings of the personal computer that will display the multi screen must be configured. For details on the personal computer's DNS settings, consult your network administrator.

Web screen configurations (continued)

User management screen [User mng.]

The users and personal computers (IP addresses) that can access the unit from personal computers and mobile terminals are registered in the User mng. screen.

The User mng. screen consists of three tabs, [User auth.], [Host auth.] and [Priority stream].

User authentication screen [User auth.]

Click the [User auth.] tab of User mng. screen [User mng.].

Configure the user authorization settings for the personal computers and mobile terminals that can access the unit.

Up to 24 users can be registered.

<NOTE>

- If user authentication fails more than 8 times within a 30-second period from the same IP address (personal computer), access to the unit will be disabled for a certain period.

The screenshot shows the 'User auth.' tab selected. It includes a 'User auth.' section with radio buttons for 'On' and 'Off', and a dropdown for 'Authentication' set to 'Digest or Basic'. Below is a 'Set' button. The 'User name' field is empty. The 'Password' and 'Retype password' fields are empty. The 'Access level' section has radio buttons for '1. Administrator', '2. Camera control', and '3. Live only'. Below is another 'Set' button. At the bottom, the 'User check' section shows a dropdown menu with 'admin[1]' selected and a 'Delete' button.

User auth.

User authorization is set to "On" or "Off" here.

Setting value:

On	Perform user authentication.
Off	Do not perform user authentication.

Factory settings: Off

Authentication

Specify the method of user authentication to use.

Setting value:

Digest or Basic	Use digest authentication or basic authentication.
Digest	Use digest authentication.
Basic	Use basic authentication.

Factory settings: Digest or Basic

<NOTE>

- If you change the [Authentication] setting, close the web browser and perform access again.
- When [User auth.] is set to [On], network connection with the AW-RP50 will be disabled.
- When [User auth.] is set to [On] while [Authentication] is set to [Digest], network connection with the AW-RP50, AW-RP120, and AK-HRP200 will be disabled.

User name

Input the user name.

Maximum number of characters	1 to 32 half-size characters
Invalid characters	" & ; ; ¥

Factory settings: blank

Password / Retype password

Input the password.

Maximum number of characters	4 to 32 half-size characters
Invalid characters	" &

Factory settings: blank

<NOTE>

- If you enter a new name for a registered user and click the [Set] button, the user information will be overwritten.

Access level

Select one of the following settings as the user access level.

Setting value:

1. Administrator	This access level allows the user to perform all the unit's operations.
2. Camera control	This access level allows only live screen [Live] operations to be performed. The unit cannot be set.
3. Live only	This access level enables only Live screen [Live] to be displayed. The unit cannot be operated or set.

Factory settings: 3. Live only

User check

You can view registered users by clicking [▼] for [User check].

A registered user is indicated in the form of "Registered user name [Access level]". (Example: admin[1])

You can delete selected users by clicking the [Delete] button at the right.

■ Host authentication screen [Host auth.]

Click the Host auth. tab of User mng. screen.

Configure the host authorization settings that restrict the personal computers (IP addresses) that can access the unit.

Host auth.

Host authorization is set to “On” or “Off” here.

Setting value:

On	Perform host authentication.
Off	Do not perform host authentication.

Factory settings: Off

IP address

The IP address of the personal computer from which access to the camera is allowed is input here. The host name cannot be input as the IP address.

<NOTE>

- When the “IP address/subnet mask length” is input, the personal computers which are allowed to access the camera can be restricted on a subnet by subnet basis.
If, for instance, “192.168.0.1/24” has been input and the [2. Camera control] setting has been selected as the [Access level] setting, the personal computers from “192.168.0.1” to “192.168.0.254” will be able to access the camera at the [2. Camera control] access level.
- When an already registered IP address is input and the Set button is clicked, the host information will be overwritten.

Access level

Select one of the following settings as the host access level.

Setting value:

1. Administrator	This access level allows the user to perform all the unit's operations.
2. Camera control	This access level allows only Live screen [Live] operations to be performed. The unit cannot be set.
3. Live only	This access level enables only Live screen [Live] to be displayed. The unit cannot be operated or set.

Factory settings: 3. Live only

Host check

You can view registered host IP addresses by clicking [▼] for [Host check].

A host is indicated in the form of “Registered IP address [Access level]”. (Example: 192.168.0.21 [1])

You can delete selected hosts (IP addresses) by clicking the [Delete] button at the right.

■ Priority stream screen [Priority stream]

Click the [Priority stream] tab of User mng. screen [User mng.].

Selected on this screen are the settings for the priority stream which enables the images to be sent with no reduction in image quality or image refresh speed even when a multiple number of users are accessing the unit at the same time.

● Priority stream

Activation

Whether to use priority stream transmission is set here using “On” or “Off”.

Setting value:

On	Use priority stream transmission.
Off	Do not use priority stream transmission.

Factory settings: Off

<NOTE>

- When [Activation] is set to [On], the number of users that can access the unit may be restricted.

Destination IP address (1)

The IP address of the first send destination is input here.

Destination IP address (2)

The IP address of the second send destination is input here.

Stream Type

Select the stream type

Setting value:

JPEG(1)	JPEG(1) images are sent.
JPEG(2)	JPEG(2) images are sent.
JPEG(3)	JPEG(3) images are sent.
H.264(1) Windows	H.264(1) images are sent.
H.264(2) Windows	H.264(2) images are sent.
H.264(3) Windows	H.264(3) images are sent.
H.264(4) Windows	H.264(4) images are sent.

Factory settings: JPEG(1)

<NOTE>

- When [Transmission priority] (→ page 74) is set to [Best effort] for [H.264], transmissions will occur at a variable bit rate between the maximum and minimum bit rate depending on the connection status of the other users. [Windows](#)

Refresh interval

Select the frame rate.

This is enabled only when [Stream Type] is set to [JPEG(1)], [JPEG(2)], or [JPEG(3)].

Setting value:

For 59.94Hz:

1fp / 2fps / 3fps / 5fps / 6fps* / 10fps* / 15fps*1 / 30fps*1

For 50Hz:

1fps/2fps/5fps/10fps* /12.5fps*1 /25fps*1

Factory settings: 1 fps

- *1 When [H.264 transmission] is set to [On], the frame rate may be slower than the specified value in some cases.

Network setup screen [Network]

Configure network settings in the Network setup screen. The Network setup screen consists of the two tabs of “Network” and “Advanced”.

Network setup screen [Network]

Click the “Network” tab of the Network setup screen.

The screenshot shows the Network setup screen with the following settings:

- IPv4 network:**
 - Network Settings: Static
 - IP address(IPv4): 192.168.0.10
 - Subnet mask: 255.255.255.0
 - Default gateway: 192.168.0.1
 - DNS: Auto (selected)
 - Primary server address: 0.0.0.0
 - Secondary server address: 0.0.0.0
- IPv6 network:**
 - Manual: Off (selected)
 - IP address(IPv6):
 - Default gateway:
 - DHCPv6: Off (selected)
 - Primary DNS server address:
 - Secondary DNS server address:
- Common:**
 - HTTP port: 80 (1-65535)
 - Line speed: Auto
 - Max RTP packet size: Unlimited(1500byte) (selected)
 - HTTP max segment size(MSS): Unlimited(1460byte)
 - Bandwidth control(bit rate): Unlimited
 - Easy IP Setup accommodate period: 20min (selected)
- Recommended network setting for internet:** (Set button)

The following information is required to configure network settings. Consult your network administrator or Internet service provider.

- IP address
- Subnet mask
- Default gateway (when using a gateway server or router)
- HTTP port
- DNS primary and secondary server addresses (when using DNS)

IPv4 network

Network Settings

Select the method in which the IP address is configured.

Setting value:

Static	Enter the IP address in the [IP address(IPv4)] field.
DHCP	Use the DHCP function to configure the IP address.
Auto(AutoIP)	Use the DHCP function to configure the IP address. If the DHCP server cannot be found, the IP address will be configured automatically.
Auto(Advanced)	Use the DHCP function to browse network address information, and configure an unused IP address for the camera as a fixed IP address. The IP address configured will be automatically determined by the camera from within the subnet mask range. If the DHCP server cannot be found, the IP address will be set to 192.168.0.10.

Factory settings: Static

<NOTE>

- If the DHCP server cannot obtain an IP address with [Auto (AutoIP)], search for an IP address between 169.254.1.0 to 169.254.254.255 on the same network, and configure the IP address.
- When set to anything other than [Static], AW-RP120's automatic configuration of IP address (AUTO IP) and AW-RP50's automatic configuration of IP address (AUTO SET IP) cannot be used.

IP address (IPv4)

Input the unit's IP address here when the DHCP function is not going to be used. Input an address that will not duplicate an existing IP address which has been set for a personal computer or another network camera.

Factory settings: 192.168.0.10

<NOTE>

- Multiple IP addresses cannot be used even when the DHCP function is used. For details on the DHCP server settings, consult your network administrator.

Subnet Mask

Input the unit's subnet mask here if the DHCP function is not going to be used.

Factory settings: 255.255.255.0

Default gateway

Input the unit's default gateway if the DHCP function is not going to be used.

Factory settings: 192.168.0.1

<NOTE>

- Multiple IP addresses cannot be used for the default gateway even when the DHCP function is used. For details on the DHCP server settings, consult your network administrator.

DNS

Whether the DNS server address is to be acquired automatically (Auto) or manually (Manual) is input here. If “Manual” has been selected, the DNS settings must be established. If “Auto” is selected when the DHCP function is going to be used, the DNS server address is acquired automatically. For further details, consult your system administrator.

Setting value: Auto / Manual

Factory settings: Manual

Primary server address

Secondary server address

Input the IP address of the DNS server if the “Manual” setting has been selected for “DNS”.

For details on the IP address of the DNS server, consult your system administrator.

Web screen configurations (continued)

● IPv6 network

Manual

Enable or disable manual configuration of the IPv6 address.

Setting value:

On	Enter the IPv6 address manually.
Off	Disable manual entry of the IPv6 address.

Factory settings: Off

IP address (IPv6)

When [Manual] is set to [On], the IPv6 address must be entered manually.

Be sure to enter an address unique from other devices.

<NOTE>

- When connecting to the manually specified IP address through a router, use an IPv6-compatible router, and enable the automatic configuration function for the IPv6 address. Be sure to configure an IPv6 address that includes the prefix information provided by the IPv6-compatible router. For details, refer to the operating instructions for the router.

Default gateway

When [Manual] is set to [On] for [IPv6 network], enter the default gateway for the unit's IPv6 network.

Factory settings: blank

DHCPv6

Enable or disable use of the IPv6 DHCP function.

Configure the DHCP server so that the same IP address is not configured for a personal computer that does not use the DHCP function and other network cameras. For details on server settings, consult your network administrator.

Setting value:

On	Use the IPv6 DHCP function.
Off	Do not use the IPv6 DHCP function.

Factory settings: Off

Primary DNS server address

Secondary DNS server address

Enter the IPv6 address of the DNS server.

For details on the IPv6 address of the DNS server, consult your system administrator.

● Common (to IPv6/IPv4)

HTTP port

Port numbers are allocated separately.

Setting range: 1 to 65535

The following port numbers are used by the unit so they cannot be used.

20, 21, 23, 25, 42, 53, 67, 68, 69, 110, 123, 161, 162, 443, 554, 995, 10669, 10670, 59000 to 61000

Factory settings: 80

Line speed

Select one of the following data line speeds. Normally, it is recommended that the [Auto] default setting be used.

Setting value:

Auto	The line speed is set automatically.
100 M-Full	100 Mbps full duplex
100 M-Half	100 Mbps half duplex
10 M-Full	10 Mbps full duplex
10 M-Half	10 Mbps half duplex

Factory settings: Auto

Max RTP packet size

Specify whether to limit the size of RTP packets sent from the camera when using RTP to view camera images.

Setting value:

Unlimited (1500byte)	Unlimited (1500 byte)
Limited (1280byte)	Limited (1280 byte)

Factory settings: Unlimited (1500byte)

Normally, it is recommended that the [Unlimited(1500byte)] setting be used.

Select [Limited(1280byte)] when the packet size of the used communication line is limited. For details on the maximum packet size of communication lines, consult your network administrator.

HTTP max segment size (MSS)

Select whether to limit the maximum segment size (MSS) transmitted by a camera when viewing camera images using HTTP.

Setting value:

Unlimited (1460byte)	Unlimited (1460 byte)
Limited (1280byte)	Limited (1280 byte)
Limited (1024byte)	Limited (1024 byte)

Factory settings: Unlimited (1460byte)

Normally, it is recommended that the default setting be used.

Select [Limited(1024byte)] / [Limited(1280byte)] when the maximum segment size (MSS) of the used communication line is limited. For details on the maximum segment size (MSS) of communication lines, consult your network administrator.

Bandwidth control (bit rate)

Select the amount of data to be distributed.

Setting value:

Unlimited / 64kbps / 128kbps / 256kbps / 384kbps / 512kbps / 768kbps / 1024kbps / 2048kbps / 4096kbps / 8192kbps

Factory settings: Unlimited

<NOTE>

- Set [Audio Mode] to [Off] when selecting [64kbps]. (→page 57, page 76)
- When [Bandwidth control (bit rate)] is set to a low value, the SnapShot button may not work depending on the use environment. In such a case, select [JPEG] with the [Compression] button in the Live screen [Live] and execute SnapShot when distributing images in the smallest resolution.

Easy IP Setup accommodate period

Select "20min" or "Unlimited" as the time for enabling the operation of the network settings from the Easy IP Setup Software.

Setting value:

20min	The setting operations from the Easy IP Setup Software are enabled for 20 minutes after the camera has started operating.
Unlimited	The setting operations from the Easy IP Setup Software are enabled at all times.

Factory settings: Unlimited

<NOTE>

- The camera screen can be opened because the camera display in the Easy IP Setup Software is constantly enabled.
- For details on the address settings of each server, consult your network administrator.
- The port forwarding function converts a global IP address to a private IP address, and includes "static IP masquerade" and "network address translation (NAT)". This function is set to the router.
- To access the camera via the Internet after connecting it to a router, it will be necessary to set an individual HTTP port No. for each network camera and to convert the address using the router's port forwarding function. For details, refer to the operating instructions for the router.

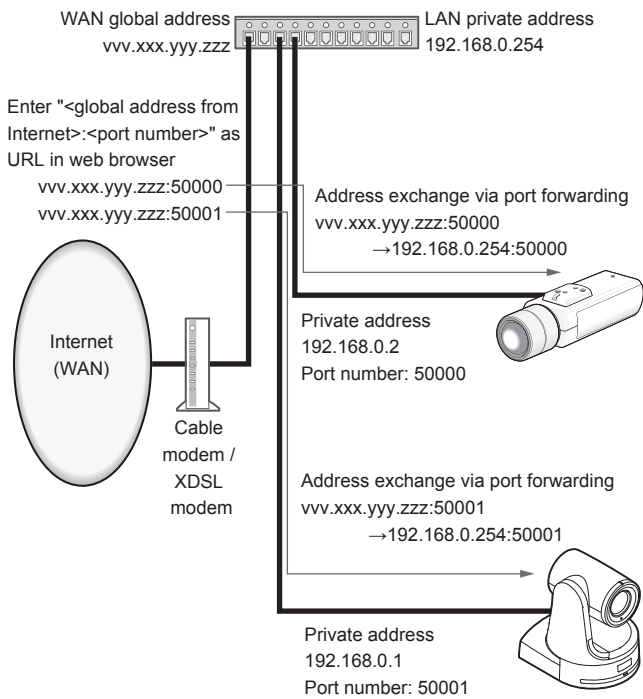

Recommended network setting for internet

Perform the recommended settings to connect the camera to the Internet.
 Clicking the [Set] button displays a dialog box telling the user that item settings will be changed. After confirming this, click the [OK] button.

- **Camera image's "JPEG/H.264" tab**
 - JPEG(1)**
Image capture size: 640×360
 - JPEG(2)**
Image capture size: 320×180
 - JPEG(3)**
Image capture size: 160×90
 - H.264(1) • H.264(2) • H.264(3) • H.264(4)** [Windows](#)
Internet mode (over HTTP): On
Transmission priority: Best effort
 - H.264(1)** [Windows](#)
Image capture size: 1280×720
Max bit rate (per client): Max1024 kbps, Min1024 kbps
 - H.264(2)** [Windows](#)
Image capture size: 640×360
Max bit rate (per client): Max1024 kbps, Min128 kbps
 - H.264(3)** [Windows](#)
Image capture size: 320×180
Max bit rate (per client): Max1024 kbps, Min128 kbps
 - H.264(4)** [Windows](#)
Image capture size: 160×90
Max bit rate (per client): Max1024 kbps, Min128 kbps
- **"Network" tab in the Network setting screen**
 - Common IPv6/v4**
Max RTP packet size: Limited (1280 byte)
HTTP max segment size(MSS): Limited (1280 byte)

Advanced network setting screen [Advanced]

Click the [Advanced] tab in the network setup screen [Network]. Settings relating to the NTP, UPnP, HTTPS, SNMP, and Diffserv functions are performed here. Click the links to each item to move to the respective setting page.

● **NTP**

Settings relating to the NTP server address and port No. are performed here.

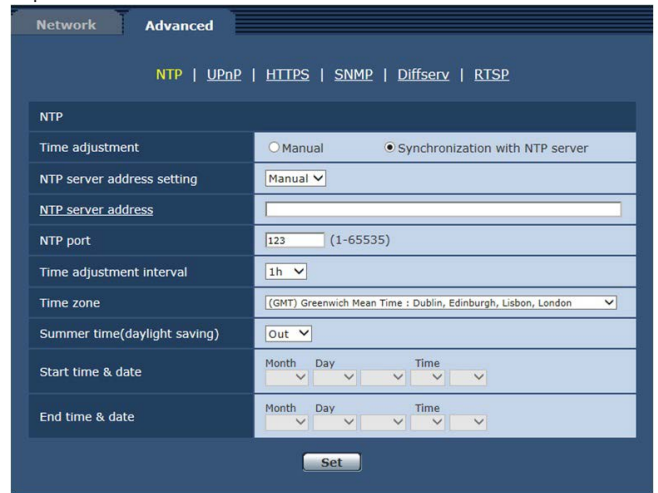

Time adjustment

Sets the method to adjust the time. The adjusted time will be used as this unit's standard time.

Setting value:

Manual	The time set in [Date / Time] of the Basic screen [Basic] will be used as this unit's standard time.
Synchronization with NTP server	The time adjusted automatically through synchronization with the NTP server will be used as this unit's standard time.

Factory settings: Synchronization with NTP server

NTP server address setting

Select the method to acquire the NTP server address.

Setting value:

Auto	Acquires the NTP server address from the DHCP server.
Manual	Sets the address by inputting the NTP server address in [NTP server address].

Factory settings: Manual

<NOTE>

- To acquire the NTP server address from the DHCP server, [Network Settings] (→ page 89) must be set to either [DHCP], [Auto(AutoIP)] or [Auto(Advanced)] in the [Network] tab of the network setup screen [Network].

NTP server address

When [Manual] is selected in the [NTP server address setting], input the IP address or host name of the NTP server.

Maximum number of characters	1 to 128 half-size characters
Characters that can be entered	Half-size alphanumeric characters, half-size symbols : . _ -

Factory settings: blank

<NOTE>

- To input the [NTP server address] host name, the [DNS] setting must be selected on the [Network] tab of the network setup screen [Network] (→ page 89).

Web screen configurations (continued)

NTP port

Input the port No. of the NTP server.

Port Nos. that can be selected: 1 to 65535

The following port numbers are used by the unit so they cannot be used.

20, 21, 23, 25, 42, 53, 67, 68, 69, 80, 110, 161, 162, 443, 554, 995, 10669, 10670

Factory settings: 123

Time adjustment interval

Selects the interval (1 to 24 hours in 1-hour increments) for acquiring the time from the NTP server.

Setting range: 1h to 24h

Factory settings: 1h

Time zone

Selects the time zone according to the region where the camera is being used.

Factory settings:

(GMT)Greenwich Mean Time: Dublin, Edinburgh, Lisbon, London

Summer time(daylight saving)

Sets whether to use summer time.

Selects the time zone that corresponds with the region in which the unit is going to be used.

Setting value:

In	Sets the time to summer time.
Out	Cancels summer time.
Auto	Switches to summer time according to the start/end time and date settings (time, day, week, month).

Factory settings: Out

Start time & date

End time & date

Sets the summer time start/end time and date by time, day, week and month when [Auto] is selected in the [Summer time(daylight saving)] setting.

● UPnP

This unit supports UPnP (Universal Plug and Play). Using the UPnP function allows the following to be set automatically.

- Sets the router's port forwarding function. (However, a UPnP-compatible router is necessary).
This setting is useful when accessing the camera from the Internet or a portable terminal.
- It is set so that a short cut to the camera is created in the "Network" folder of your personal computer and that short cut is automatically renewed even when the camera's IP address is changed.



Auto port forwarding

Whether to use the router's port forwarding function is set by selecting "On" or "Off".

To use the automatic port forwarding function, the used router must support UPnP and the UPnP function must be enabled.

Setting value:

On	Uses the router's port forwarding function.
Off	The router's port forwarding function is not used.

Factory settings: Off

<NOTE>

- The port number may be changed by automatic port forwarding. If the number is changed, the port No. of the camera registered to the personal computer or recorder must be changed.
- The UPnP function may be used when the camera is connected to the IPv4 network. IPv6 is not supported.
- To confirm that automatic port forwarding is correctly set, click the [Status] tab in the maintenance screen [Maintenance] to confirm that the [UPnP] status is set to [Enable]. (→ page 102)
If [Enable] is not displayed, refer to "Cannot access the Internet from the Camera" in the "Troubleshooting" section. (→ page 113)

Camera short cut

Whether to create a camera short cut in the [Network] folder of your personal computer is set by selecting "On" or "Off".

Select [On] to create a camera short cut.

To use the camera short cut function, enable the UPnP function in advance in your personal computer.

Setting value:

On	Creates a camera short cut in the "Network" folder of your personal computer.
Off	No camera short cut is created in the "Network" folder of your personal computer.

Factory settings: Off

<NOTE>

- To display a camera short cut in the Windows [Network] folder, the Windows component must be added. Refer to the information below to enable UPnP.

Windows 7

[Start]→[Control Panel]→[Network and Internet]→[Network and Sharing Center]→[Change Advanced Sharing Settings]→select [Enable Network Discovery] in [Network Discovery]→click [Save Changes]→Complete

Windows 8

[Start]→Select [All Applications]→[Control Panel]→[Network and Internet]→[Network and Sharing Center]→[Change Advanced Sharing Settings]→select [Enable Network Discovery] in [Network Discovery]→click [Save Changes]→Complete

● HTTPS

Using the HTTPS function enables access to the camera to be encrypted and communication safety to be improved.
See page 95 for more details on the HTTPS setup method.

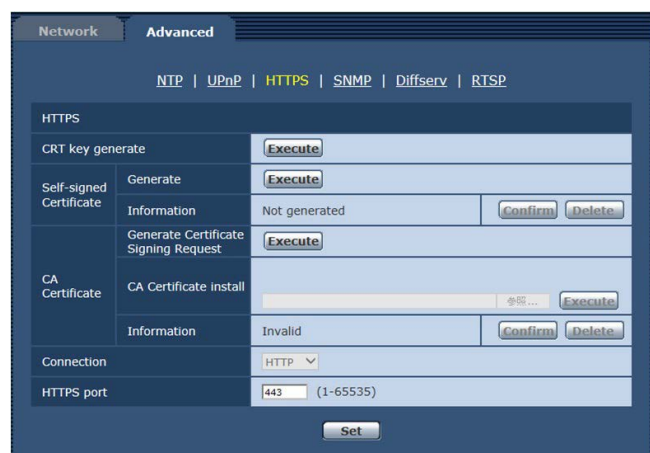

CRT key generate

A CRT key (SSL encryption key) is generated by HTTPS.

To generate a CRT key, click the [Execute] button to display the [CRT Key Generate] dialog.

For more details, refer to "Generating a CRT key (SSL encryption key)" (→ page 96).

Self-signed Certificate - Generate

A self-signed security certificate is generated by HTTPS. (Self-signed Certificate)

To generate a self-signed certificate (security certificate), click the [Execute] button to display the [Self-signed Certificate - Generate] dialog and perform the operation.

For more details, refer to "Generating a Self-signed Certificate (Security Certificate)" (→ page 96).

Self-signed Certificate - Information

This displays information relating to the self-signed certificate (security certificate).

When the [Confirm] button is clicked, the registered content of the generated self-signed certificate (security certificate) is displayed in the [Self-signed Certificate - Confirm] dialog.

Click the [Delete] button to delete the generated self-signed certificate (security certificate).

CA Certificate - Generate Certificate Signing Request

When using a security certificate issued by the Certificate Authority (CA) as a security certificate for HTTPS, a Certificate Signing Request (CSR) is generated for application to the Certificate Authority (CA). To generate a Certificate Signing Request (CSR), click the [Execute] button to display the [Certificate Signing Request (CSR) Generate] dialog and perform the operation.

For more details, refer to "Generating a Certificate Signing Request (CSR)" (→ page 97).

CA Certificate - CA Certificate install

This displays information relating to server certificates (security certificates) issued by the Certificate Authority (CA), which are to be or are already installed.

In the [File Open] dialog, which is displayed by clicking the [Browse] button, select the file of the server certificate (security certificate) issued by the Certificate Authority (CA) and click the [Execute] button to install the server certificate (security certificate).

If the server certificate (security certificate) is installed, its file name will be displayed.

For more details, refer to "Installing the Server Certificate" (→ page 98).

CA Certificate - Information

This displays information relating to the server certificate (security certificate).

When the [Confirm] button is clicked, the registered content of the installed server certificate (security certificate) is displayed in the [Server Certificate - Confirm] dialog. If the server certificate (security certificate) is not installed, the content of the generated Certificate Signing Request (CSR) is displayed.

Click the [Delete] button to delete the installed server certificate (security certificate).

<NOTE>

- To delete an enabled server certificate (security certificate), confirm that there is a backup to the said certificate in your personal computer or recording media. A server certificate (security certificate) will be needed to reinstall it.

Connection

This sets the method to connect to the unit.

Setting value:

HTTP	Only HTTP connection is possible.
HTTPS	Only HTTPS connection is possible.

Factory settings: HTTP

For more details, refer to "Setting the Connection Method" (→ page 98).

<NOTE>

- When using an HTTPS connection, network connection with the AW-RP50, AW-RP120, and AK-HRP200 will be disabled.

HTTPS port

This sets the Port No. to be used with HTTPS.

Port Nos. that can be selected: 1 to 65535

The following port numbers are used by the unit so they cannot be used.

20, 21, 23, 25, 42, 53, 67, 68, 69, 80, 110, 123, 161, 162, 554, 995, 10669, 10670, 59000 to 61000

Factory settings: 443

<NOTE>

- This unit will restart if the connection method is changed.
- When using a self-signed certificate:
 - A warning screen is displayed when accessing the camera by HTTPS for the first time. Install the self-signed certificate (security certificate) in your personal computer in accordance with the screen instructions. (→ page 99)
- When using a server certificate:
 - Install the Certificate Authority (CA) root certificate or intermediate certificate in your web browser in advance.
 - Follow the Certificate Authority (CA) procedures to acquire and install root certificates and intermediate certificates.
- When accessing the camera by HTTPS, the image display speed and frame rate of the moving image may reduce.
- When accessing the camera by HTTPS, it may take some time for the images to be displayed.
- When accessing the camera by HTTPS, images may be disturbed and sound may be interrupted.
- The maximum number of cameras that can be connected simultaneously depends on the maximum image size and distribution format.

SNMP

This performs settings relating to the SNMP function. The status of the unit can be confirmed by connecting to it with SNMP manager. To use the SNMP function, consult your network administrator.

SNMP version

Sets the SNMP version to be enabled.

Setting value:

SNMPv1 / v2	Operation will occur using SNMPv1 or SNMPv2. Either version will be used, or the operation mode of the SNMP manager will decide.
SNMPv3	Operation will occur using SNMPv3. The operation mode of the SNMP manager will not operate on a setting other than SNMPv3.
SNMPv1 / v2 / v3	Operation will occur using SNMPv1, SNMPv2 or SNMPv3. Either version will be used, or the operation mode of the SNMP manager will decide.

Factory settings: SNMPv1 / v2

<NOTE>

- When using SNMPv1 or SNMPv2, be sure to input the [Community] field. The SNMP function cannot be used if the [Community] field is left blank.
- When using SNMPv3, be sure to input the [User name] and [Password] fields, and select the desired [Authentication] and [Encryption method]. The SNMP function cannot be used if any of these fields are left blank.
- The transmissions are encrypted only during SNMPv3 operation.

SNMPv1/v2 - Community

Input the name of the community to be monitored.

Maximum number of characters	0 to 32 half-size characters
Invalid characters	Full size characters

Factory settings: blank

Web screen configurations (continued)

SNMPv3 - User name

Input the user name for user authentication.

The user name that you input here will need to be specified in the SNMPv3 manager.

Maximum number of characters	0 to 32 characters
Invalid characters	Full-size characters

Factory settings: blank

SNMPv3 - Authentication

Sets the algorithm to be used for user authentication.

Setting value:

MD5	The MD5 algorithm will be used for user authentication.
SHA1	The SHA1 algorithm will be used for user authentication.

Factory settings: MD5

SNMPv3 - Encryption method

Sets the encryption method to be used for transmissions.

Setting value:

DES	DES encryption method for SNMPv3 will be used for transmissions.
AES	AES encryption method for SNMPv3 will be used for transmissions.

Factory settings: DES

SNMPv3 - Password

Sets the password to be used for user authentication.

The password that you input here will need to be specified in the SNMPv3 manager.

Maximum number of characters	When [Authentication] is set to [MD5]: 8 to 16 characters When [Authentication] is set to [SHA1]: 8 to 20 characters
Invalid characters	Full-size characters

Factory settings: blank

System name

Input the name of the system to control the unit with the SNMP function.

Maximum number of characters	0 to 32 half-size characters
Invalid characters	Full size characters

Factory settings: blank

Location

Input the location where the unit has been installed.

Maximum number of characters	0 to 32 half-size characters
------------------------------	------------------------------

Factory settings: blank

Contact

Input the email address or telephone number of the administrator.

Maximum number of characters	0 to 255 half-size characters
Invalid characters	Full size characters

Factory settings: blank

Diffserv

This performs settings relating to the Diffserv function. The Diffserv function sets the priority of image/audio data transmitted from the router.

Priorities set to this unit must be aligned with DSCP values set to the router.

To use the Diffserv function, consult your network administrator.

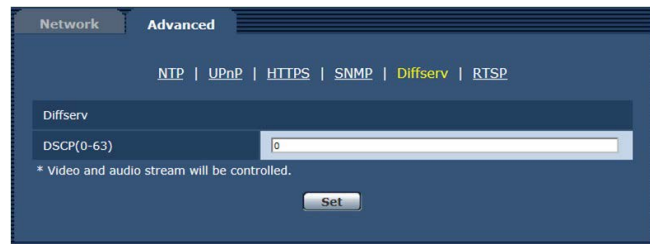

DSCP(0-63)

Input the packet priority.

Maximum number of characters	0 to 63 half-size characters
------------------------------	------------------------------

Factory settings: 0

RTSP

This performs settings related to the RTSP function. The RTSP function sets the RTSP transmission port and RTSP Request URL used during IP image transmission.

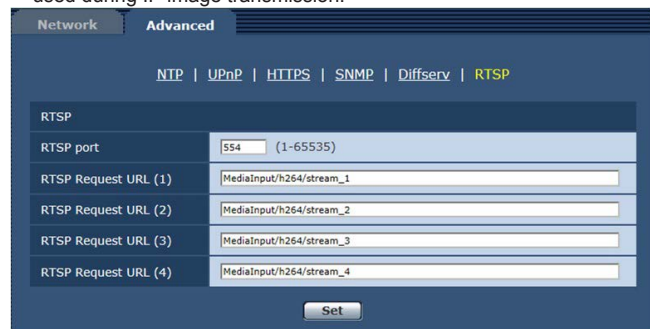

RTSP port

Sets the RTSP reception port no.

Port Nos. that can be selected: 1 to 65535

The following port numbers are used by the unit so they cannot be used.

20, 21, 23, 25, 42, 53, 67, 68, 69, 80, 110, 123, 161, 162, 443, 995, 10669, 10670, 59000 to 61000

Factory settings: 554

RTSP Request URL (1) to (4)

Sets up the URL for RTSP when making IP image transmission demands to this unit.

RTSP Request URL (1)	RTSP URL for H.264 (1) image transmission
RTSP Request URL (2)	RTSP URL for H.264 (2) image transmission
RTSP Request URL (3)	RTSP URL for H.264 (3) image transmission
RTSP Request URL (4)	RTSP URL for H.264 (4) image transmission

Factory settings:

RTSP Request URL (1)	MediaInput/h264/stream_1
RTSP Request URL (2)	MediaInput/h264/stream_2
RTSP Request URL (3)	MediaInput/h264/stream_3
RTSP Request URL (4)	MediaInput/h264/stream_4

- Up to 255 characters can be entered.
- The following characters can be displayed.

Half-size numeric characters	0123456789
Half-size alphabetical characters (upper and lower cases)	ABCDEFGHIJKLMNOPQRSTUVWXYZ abcdefghijklmnopqrstuvwxyz
Half-size symbols	/ - _

<NOTE>

- RTSP Request URLs (1) to (4) cannot have the same URL.

HTTPS settings [HTTPS]

This encrypts access to the camera and sets HTTPS to improve communication safety. Setting HTTPS is performed by following the procedures below.

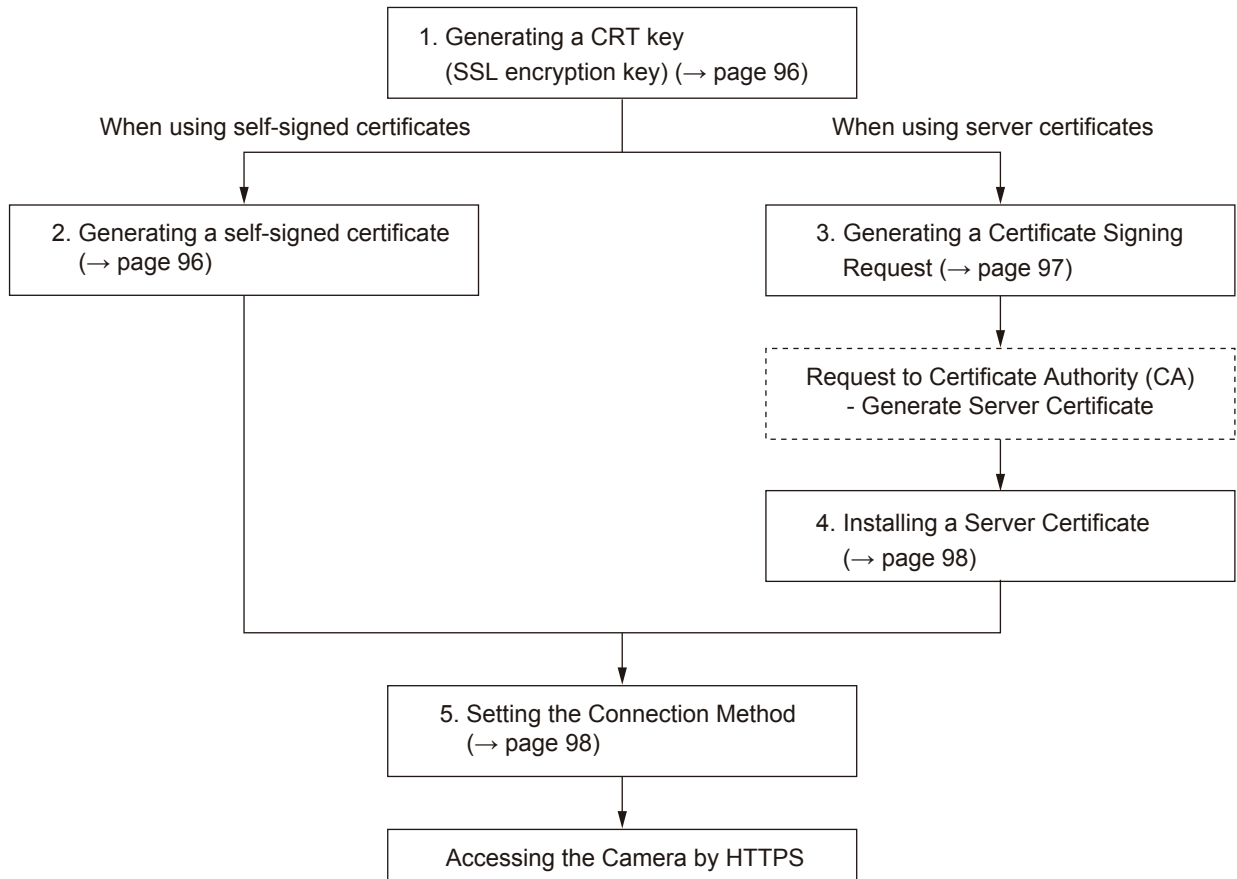
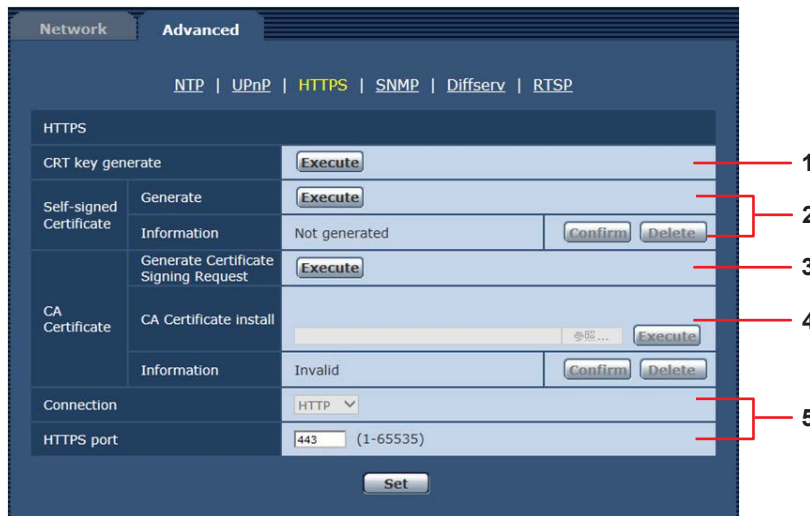

<NOTE>

- When using a server certificate, the process from applying to the Certificate Authority (CA) to issuing a server certificate must be performed between customers and the Certificate Authority (CA).
- Use either a self-signed certificate or server certificate. When simultaneously generating a self-signed certificate and installing a server certificate, this unit will prioritize the server certificate.

■ Generating a CRT key (SSL encryption key)
[CRT key generate]

<NOTE>

- A CRT key cannot be generated when self-signed certificates and server certificates are enabled.
- The size of the key that can be used by the Certificate Authority (CA) differs when using a server certificate. Confirm in advance the size of the key that can be used.
- Generating a CRT key takes about 1 minute for 1024 bit and about 2 minutes for 2048 bit. Do not operate the web browser until CRT key generation is complete. Image display and communication speed may reduce while generating a CRT key.

1. Click the [Execute] button in [CRT key generate].

The [CRT key generate] dialog is displayed.

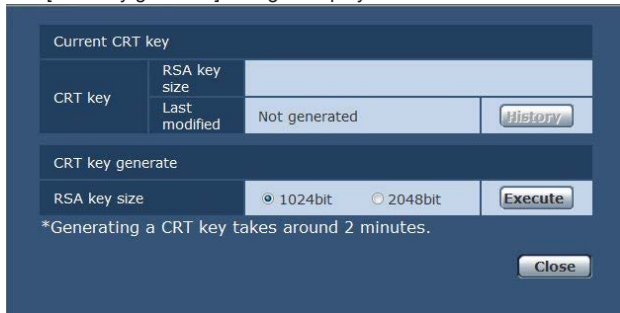

2. The size of the generated CRT key is selected from [1024bit] / [2048bit] in [CRT key generate] – [RSA key size].

<NOTE>

- When using a server certificate, the RSA key size must be in accordance with the demands of the Certificate Authority (CA) which will be applied to.

3. Click the [Execute] button.

CRT key generation starts.

When CRT key generation stops, the size of the CRT key generated by the [Current CRT key] and the date and time generation concluded will be displayed.

<NOTE>

- Perform procedures 1 to 3 to change (update) the generated CRT key. Because the CRT key, self-signed certificate and server certificate are enabled as a set, it will be necessary to once again generate a self-signed certificate or apply for a server certificate when the CRT key is changed.
- When the CRT key is changed, previous CRT keys are historically managed one at a time.

Clicking the [Apply] button in the [Current CRT key] of the [CRT key generate] dialog displays the [Previous CRT key] dialog, allowing confirmation of the key size and the date and time generation was completed.

Clicking the [Apply] button in [Previous CRT key] allows the previous CRT key to be switched to the current CRT key.



■ Generating a self-signed certificate
[Self-signed Certificate - Generate]

<NOTE>

- A self-signed certificate cannot be generated when a CRT key has not been generated.

1. Click the [Execute] button in [Self-signed Certificate] - [Generate].

[Self-signed Certificate - Generate] is displayed.

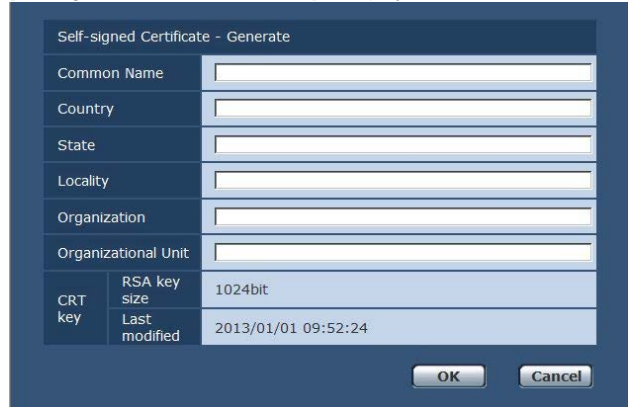

2. Input information relating to the certificate to be generated.

Items to be entered are as follows.

Item	Description	Maximum number of characters
Common Name	Inputs the camera address or host name.	64 half-size characters
Country	Inputs the country code. (can be abbreviated)	2 half-size characters: country code
State	Inputs the name of the state. (can be abbreviated)	128 half-size characters
Locality	Inputs the name of the city. (can be abbreviated)	128 half-size characters
Organization	Inputs the name of the organization. (can be abbreviated)	64 half-size characters
Organizational Unit	Inputs the name of the organizational unit. (can be abbreviated)	64 half-size characters
CRT key	Displays the size of the current CRT key and the date and time generation was completed.	

<NOTE>

- Characters that can be input for [Common Name], [Country], [State], [Locality], [Organization], [Organizational Unit] are 0 to 9 (half-size characters), A to Z (half-size characters), a to z (half-size characters), and the following half-size symbols: - , _ , + / ().
- When connecting the camera to the Internet, set the address or host name to be accessed from the Internet in [Common Name]. In this case, when accessing the camera locally, a security warning screen is displayed every time the camera is accessed even when a security certificate is installed.
- When inputting the IPv6 address in [Common Name], surround the address with [].
 e.g. [2001:db8::10]

3. Click the [OK] button after inputting the address.

A self-signed certificate is generated.

<NOTE>

- Information relating to the generated self-signed certificate is displayed in [Self-signed Certificate] - [Information]. The following is displayed depending on the status of the self-signed security certificate.

Displayed content	Description
Not generated	When the self-signed certificate is not generated
Invalid (Reason: CA Certificate installed)	When the self-signed certificate is already generated and the server certificate is already installed <ul style="list-style-type: none"> The server certificate is enabled in this case.
[Common Name] of self-signed certificate	When the self-signed certificate is already generated and enabled

- When the [Confirm] button is clicked, the registered content of the generated self-signed certificate (security certificate) is displayed in the [Self-signed Certificate Confirm] dialog.

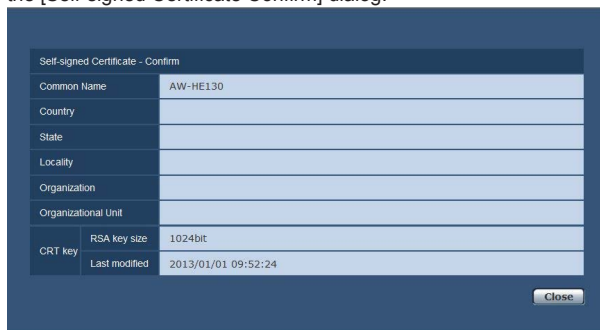

- Click the [Delete] button to delete the generated self-signed certificate (security certificate).
- When [HTTPS] is selected in [Connection], the self-signed certificate (security certificate) cannot be deleted.

■ Generating a Certificate Signing Request (CSR) [CA Certificate - Generate Certificate Signing Request]

<NOTE>

- A certificate signing request (CSR) cannot be generated if a CRT key has not been generated.
- To generate a certificate signing request (CSR), perform the following settings in advance in the web browser Internet options. Perform the following settings in the [Security] tab (accessed from [Tools] in the menu bar - [Internet Options] - [Security]).
- Register the camera as a [Trusted Site].
- In [Level Customize], go to [File Download] from [Download] and set to [Enable].
- In [Level Customize], go to [Automatically Display Dialog when Downloading File] from [Download] and set to [Enable].

1. Click the [Execute] button in [CA Certificate] - [Generate Certificate Signing Request].

The [CA Certificate - Generate Certificate Signing Request] dialog is displayed.

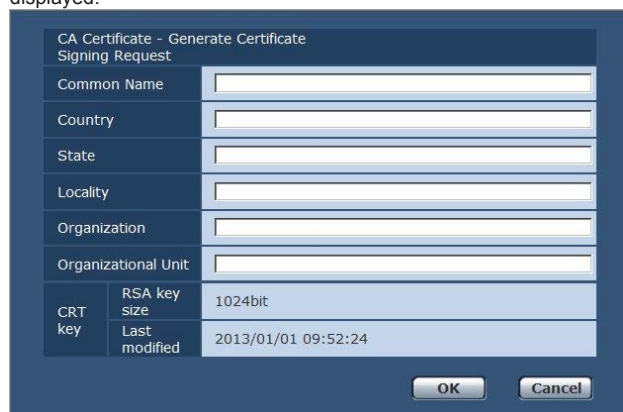

2. Input information relating to the certificate to be generated

Items to be entered are as follows.

Item	Description	Maximum number of characters
Common Name	Inputs the camera address or host name.	64 half-size characters
Country	Inputs the country code.	2 half-size characters: country code
State	Inputs the name of the state.	128 half-size characters
Locality	Inputs the name of the city.	128 half-size characters
Organization	Inputs the name of the organization.	64 half-size characters
Organizational Unit	Inputs the name of the organizational unit.	64 half-size characters
CRT key	Displays the size of the current CRT key and the date and time generation was completed.	

<NOTE>

- When using a server certificate, the information to be input must be in accordance with the demands of the Certificate Authority (CA), which will be applied to.
- Characters that can be input for [Common Name], [Country], [State], [Locality], [Organization], [Organizational Unit] are 0 to 9 (half-size characters), A to Z (half-size characters), a to z (half-size characters), and the following half-size symbols: - , _ , + / ().

3. Click the [OK] button after inputting the address.

The [Save As] dialog is displayed.

4. In the [Save As] dialog, assign a file name to the Certificate Signing Request (CSR) and save it in personal computer.

Apply to the Certificate Authority (CA) using the saved Certificate Signing Request (CSR).

<NOTE>

- A server certificate is issued for both the generated Certificate Signing Request (CSR) and CRT key. The issued server certificate can no longer be used when generating/updating the CRT key after applying to the Certificate Authority (CA).
- The Certificate Signing Request (CSR) generated by this unit is in a PEM format.

■ Installing a Server Certificate

[CA Certificate - CA Certificate install]

<NOTE>

- A server certificate (security certificate) cannot be installed if a Certificate Signing Request (CSR) has not been generated.
- The server certificate must have been issued by the Certificate Authority (CA) in order to install it.

1. Click the [Browse] button in [CA Certificate] - [CA Certificate install].

The [Open File] dialog is displayed.

2. Select the server certificate file and click [Open]. Then click the [Execute] button.

The server certificate is installed.

<NOTE>

- The name of the host registered to the installed server certificate is displayed in [CA Certificate] - [Information]. The following is also displayed depending on the status of the server certificate.

Displayed content	Description
Invalid	When the server certificate is not installed
[Common Name] of server certificate	When the server certificate is already installed and enabled.
Expired	When the effective period of the server certificate has expired

- When the [Confirm] button is clicked, the content of the installed server certificate (security certificate) is displayed in the [CA Certificate - Confirm] dialog. (An asterisk is displayed in the [Organizational Unit] field only.)



- Click the [Delete] button to delete the installed server certificate (security certificate).
- When [HTTPS] is selected in [Connection], the server certificate (security certificate) cannot be deleted.
- Perform STEP 1 to STEP 2 to update a server certificate.
- To delete an enabled server certificate (security certificate), confirm that there is a backup to the said certificate in your personal computer or recording media. A server certificate (security certificate) will be needed to reinstall it.
- The HTTPS function can no longer be used when the effective period of the server certificate has expired. In such a case, the connection method is changed to HTTP when the unit is restarted. Update the server certificate before its effective period expires.
- The effective period of the server certificate can be confirmed by double-clicking the server certificate file issued by the Certificate Authority (CA).

■ Setting the Connection Method [Connection]

1. Set the method to access the camera in [Connection].

HTTP: Only HTTP connection is possible.

HTTPS: Only HTTPS connection is possible.

<NOTE>

- When using an HTTPS connection, network connection with the AW-RP50, AW-RP120, and AK-HRP200 will be disabled.

2. Set the Port No. to be used with HTTPS in [HTTPS Port].

Port Nos. that can be selected 1 to 65535

The following port numbers are used by the unit so they cannot be used.

20, 21, 23, 25, 42, 53, 67, 68, 69, 80, 110, 123, 161, 162, 554, 995, 10669, 10670, 59000 to 61000

Factory settings: 443

3. Click the [Set] button.

The camera restarts and access to the camera via HTTPS is enabled.

<NOTE>

- This unit will restart if the connection method is changed.
- **Using a self-signed certificate**
A warning screen is displayed when accessing the camera by HTTPS for the first time. Install the self-signed certificate (security certificate) in your personal computer in accordance with the screen instructions. (→ page 99)
- **Using a server certificate**
Install the Certificate Authority (CA) root certificate or intermediate certificate in your web browser in advance. Follow the Certificate Authority (CA) procedures to acquire and install root certificates and intermediate certificates.
- When accessing the camera by HTTPS, the image display speed and frame rate of the moving image may reduce.
- When accessing the camera by HTTPS, it may take some time for the images to be displayed.
- When accessing the camera by HTTPS, images may be disturbed and sound may be interrupted.
- The maximum number of cameras that can be connected simultaneously depends on the maximum image size and distribution format.

■ Accessing the Camera by HTTPS

1. Launch the web browser in your personal computer.

2. Input the camera's IP address in the address bar of the web browser.

Input address: https://192.168.0.10/

<NOTE>

- When the HTTPS port No. is changed from "443", input "https:// camera IP address: Port No." in the address bar.
E.g. https://192.168.0.11:61443
- When this unit is in a local network, set a proxy server from the web browser (menu bar: [Tools] - [Internet Options]) to ensure that a proxy server is not used for a local address.

3. Press the [Enter] key.

The Live screen is displayed.

The security certificate is installed when the security warning screen is displayed. (→ page 99)

When [User auth.] is set to [On], the user name and password input screen is displayed before the live screen [Live] appears.

<NOTE>

- When HTTPS is used, screen and image display may slow down and image update interval (frame rate) may also slow down.

● Install the security certificate

When using HTTPS to access the camera, the security warning screen will be displayed if the security certificate of the said camera has not been installed in your personal computer. To prevent this warning screen being displayed, the security certificate must be installed in accordance with the following procedures. If it is not installed, the security warning screen will be displayed every time the camera is accessed.

<NOTE>

- The security certificate will be installed to your personal computer based on the content set for [Common Name]. The content set for the "Host Name" must therefore match that set for the address/host name used to access the camera. If the content differs, a security warning screen will be displayed every time the camera is accessed.
- A security warning screen will be displayed if the camera address/host name is changed even when a security certificate has been installed. Reinstall the security certificate.
- When connecting the camera to the Internet, set the address or host name to be accessed from the Internet in [Common Name]. In this case, when accessing the camera locally, a security warning screen is displayed every time the camera is accessed even when a security certificate is installed.
- When the security certificate is correctly installed, an icon of the key will be displayed in the address bar of the web browser accessing the camera. (in the case of Internet Explorer 8.0 and 9.0)
- The screen will differ partially in the case of Internet Explorer 10 and 11.

1. Accessing the Camera by HTTPS

2. When the security warning screen is displayed, click [Continue to this website (not recommended)].

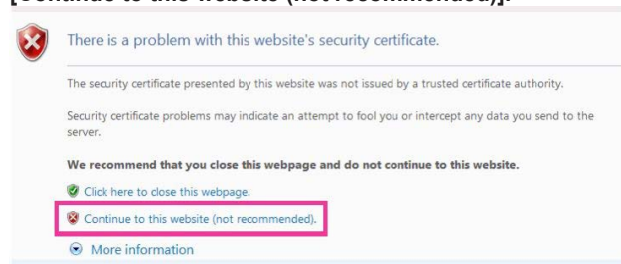

The live screen [Live] is displayed.

When the authentication screen is displayed, input the user name and password.

<NOTE>

- When the above screen is displayed after accessing a device apart from the camera or a website, there may be a security problem, so check this carefully.

3. Click [Certificate error] in the URL and then click [View certificates].

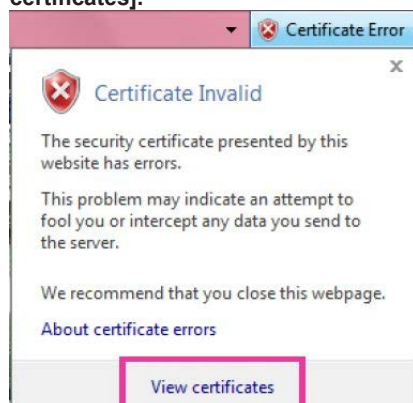

4. Click [Install Certificate...].

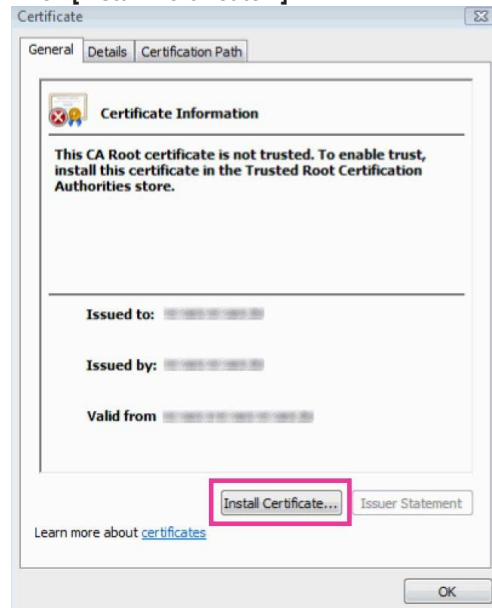

<NOTE>

- If [Install Certificate...] is not displayed, close Internet Explorer and restart it by selecting [Run as Administrator]. Right-click on [Start] - [Program] - [Internet Explorer] and click [Execute as Administrator (A)..].
- In the case of Windows 8 and 8.1, right-click on [iexplore] under [C:\Program Files\Windows 8 and 8.1] and click [Execute as Administrator (A)..].

5. Click [Next], which is displayed in the certificate import wizard.

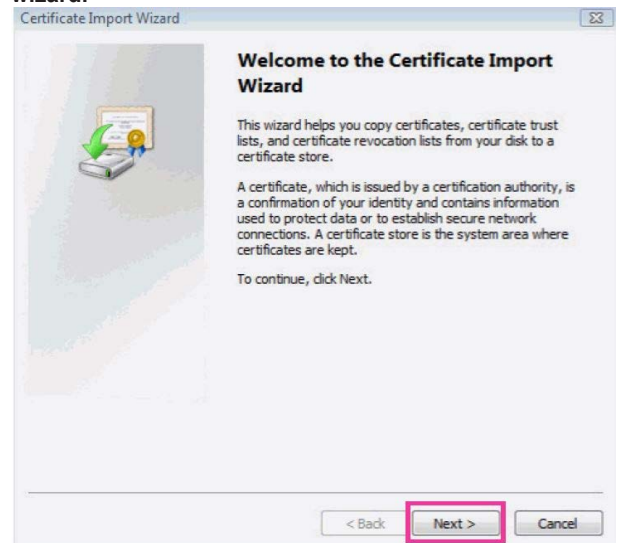

<NOTE>

- In the case of Internet Explorer 10 and 11, select the [Save destination] and click [Next].

6. Select [Place all certificates in the following store] and click [Refer (R)..].

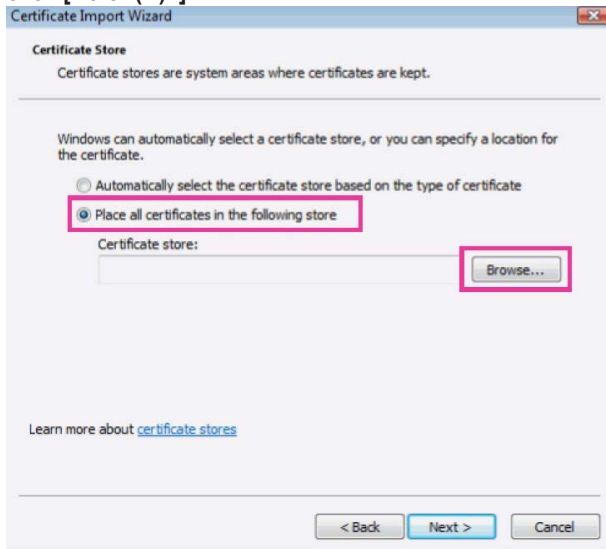

9. Click [Finish].

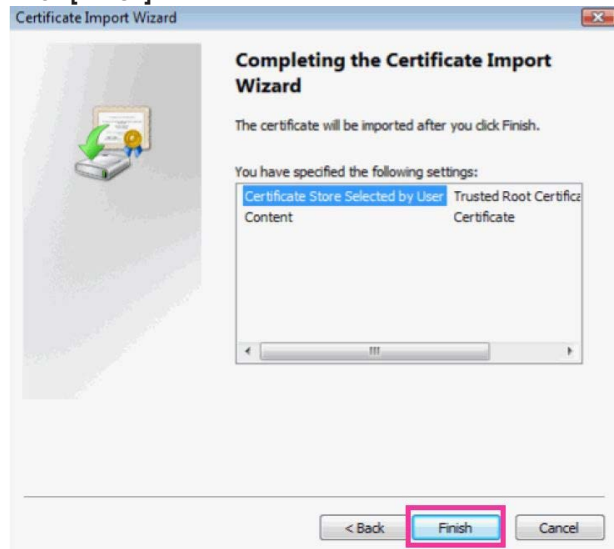

7. Select [Trusted Root Certification Authorities] and click [OK].

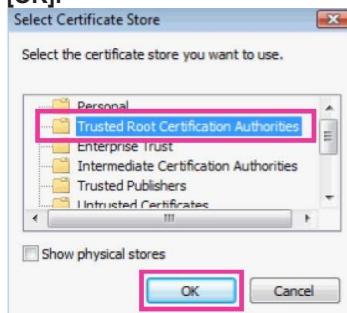

10. Click [Yes].

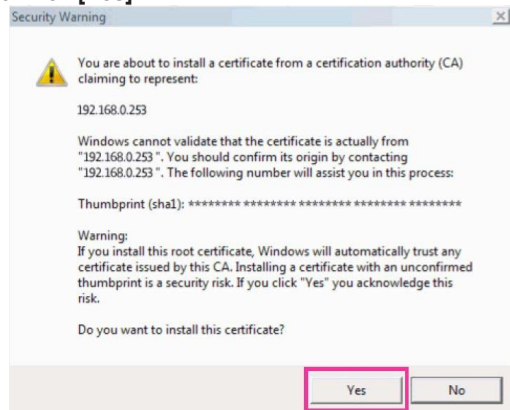

8. Click [Next].

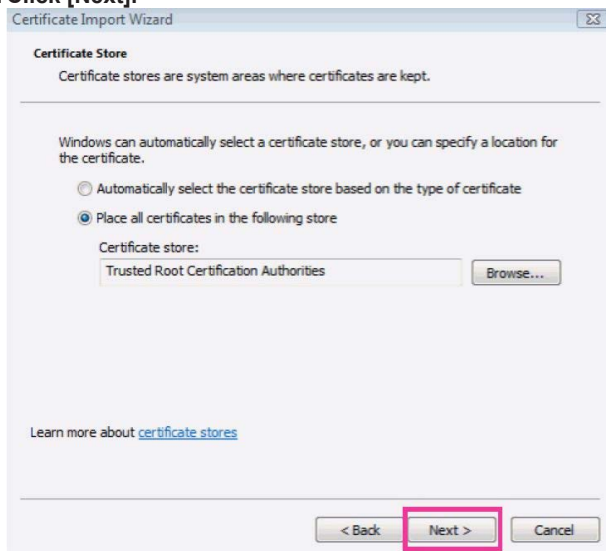

When importing is finished, the "Certificate was imported correctly" screen is displayed.

11. Click [OK].

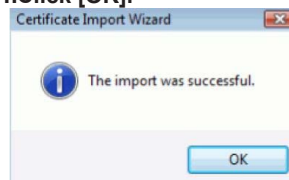

Closing the web browser after importing the certificate and reconnecting to it will stop the "Certificate error" screen being displayed.

Web screen configurations (continued)

Maintenance screen [Maintenance]

Among the various maintenance operations performed on this screen are system log checks, system version upgrading and initialization of the unit.

The Maintenance screen consists of five tabs: [System log], [Product info.], [Status], [Default reset] and [Back up].

System log screen [System log]

A maximum of 30000 system logs can be stored in the unit's internal memory.

When this maximum number has been exceeded, the old logs are overwritten successively by the new logs.

The logs are cleared when the unit's power is turned off.

<NOTE>

- The maximum number of entries that can be checked on the system log screen is 100. Entries beyond 100 can be checked by obtaining the log using CGI commands.



No	Time & date	Description
1	Feb/01/2017 00:08:37	jpeg Stop admin 192.168.0.30
2	Feb/01/2017 00:08:36	jpeg ch1 Play admin 192.168.0.30
3	Feb/01/2017 00:08:35	h264 ch1 Stop admin 192.168.0.30
4	Feb/01/2017 00:08:33	h264 ch1 Play admin 192.168.0.30
5	Feb/01/2017 00:08:29	<Login> admin

No

The running numbers of the system logs are displayed here.

Time & date

The times and dates when the logs were generated are displayed here.

The 24-hour system is used to display this information.

Description

Details of the system logs are displayed here.

For further details on the system logs, refer to page 108.

Product information screen [Product info.]

The versions of the unit's software can be checked on this screen.

The [Model no.], [MAC address], [Serial no.], [Firmware version] and other information about the unit is displayed.

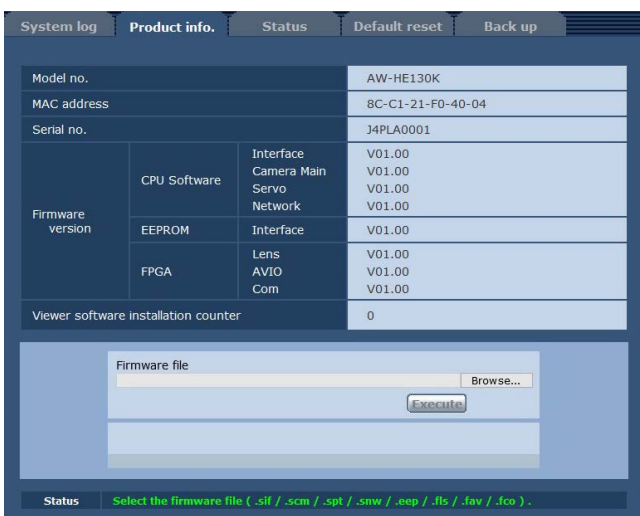

Model no.	AW-HE130K		
MAC address	8C-C1-21-F0-40-04		
Serial no.	J4PLA0001		
Firmware version	CPU Software	Interface	V01.00
		Camera Main	V01.00
		Servo	V01.00
EEPROM	FPGA	Network	V01.00
		Interface	V01.00
		Lens	V01.00
FPGA	Com	AVIO	V01.00
		Com	V01.00
Viewer software installation counter	0		

Firmware file

Status Select the firmware file (.sif / .scm / .spt / .snw / .eep / .fls / .fav / .fco).

Model no.

Display the unit's model number.

MAC address

Display the unit's MAC address.

Serial no.

Display the unit's serial number.

Firmware version

CPU Software - Interface

Display the software version of the interface.

CPU Software - Camera Main

Display the software version of the camera unit.

CPU Software - Servo

Display the software version of the servo.

CPU Software - Network

Display the software version of the network.

EEPROM - Interface

Display the version of the setup data for the interface.

FPGA - Lens

Display the FPGA version of the lens.

FPGA - AVIO

Display the FPGA version of the AVIO.

FPGA - Com

Display the FPGA version of the communication.

Viewer software installation counter

The number of plug-in viewer software applications which have been installed automatically from the unit is displayed by this counter.

Firmware file

Update the firmware.

For details on how to update, see "Updating the firmware" (→ page 101).

Status

Display the current status of the unit.

● Updating the firmware

Perform the following to update the firmware.

1. After consulting with your dealer, download the latest software to the hard disk of your personal computer.

<NOTE>

- No spaces or full-size characters can be used for the directory in which the software will be stored.
- Keep the maximum combined number of characters to be used for the name of the directory in which the software will be stored and for the name of the software which has been downloaded to less than 250 characters.

2. Click the [Browse] button, and specify the downloaded software.

3. Click the [Execute] button.

The software upgrade check screen is displayed.

After upgrading the software version, be absolutely sure to delete the temporary Internet files.

<NOTE>

- Be absolutely sure to upgrade the software versions from the personal computer in the same network (LAN) as the unit whose firmware version is to be updated.

<NOTE>

- After the [Execute] button is pressed, the amount of time it takes for the version upgrade progress bar to appear is about 1 minute for the Camera Main software or about 3 minutes for the Network software or AVIO FPGA. The progress bar will appear within 1 minute for other firmware.
- Use the personal computer on the same subnet as the camera to upgrade the software version.
- Before using the version upgrading software, be absolutely sure to check the precautions to be observed with your dealer, and follow the dealer's instructions.
- Use the following files specified by Panasonic Corporation as the software used for version upgrading.

CPU Software Interface	.sif files
CPU Software Camera Main	.scm files
CPU Software Servo	.spt files
CPU Software Network	.snw files
EEPROM Interface	.eep files
FPGA Lens	.fls files
FPGA AVIO	.fav files

- Do not turn off the unit's power while upgrading a software version. (Do not turn off the power until the progress bar display is cleared.)
- While a software version is being upgraded, do not attempt to execute any other operations until the version has been upgraded.

■ Status confirmation screen [Status]

Confirm the status of the unit.



● UPnP

Port number (HTTP)

Displays the port number configured via UPnP port forwarding.

Status

Displays the port forwarding status.

Port number (HTTPS)

Displays the port number configured via UPnP port forwarding.

Status

Displays the port forwarding status.

Router global address

Displays the global address of the router.

Reset settings screen [Default reset]

The unit's setting data is initialized and the unit is restarted on this screen.

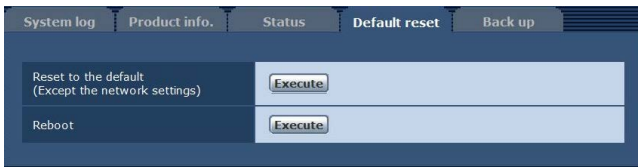

Reset to the default (Except the network settings)

When the [Execute] button is clicked, the unit's settings are returned to their defaults.

The login user name and password will also return to their defaults (admin/12345).

When the initialization operation is started, no operations can be undertaken for about 3 minutes.

<NOTE>

- The following setting items will not be returned to defaults.
 - All settings under [IPv4 network]
 - All settings under [IPv6 network]
 - [HTTP port]
 - [HTTPS - Connection]
 - [HTTPS - HTTPS port]
 - HTTPS: CRT key, server certificate
 - All settings under [UPnP]
 - [Line speed]
 - [Bandwidth control(bit rate)]
- [AWB] and [ABB] adjustment values will not be returned to defaults.

Reboot

When the [Execute] button is clicked, the unit is rebooted.

After the unit has been rebooted, no operations can be undertaken for 2 minutes as is the case when the unit's power is turned on.

Back up screen [Back up]

On this screen, the unit's settings can be saved to a personal computer or settings saved in a personal computer can be loaded into the unit for use.



Config data type

Specify the type of settings to save when saving the unit's configuration data on the personal computer.

Setting value:

Camera	Camera settings
Network	Network settings

Download

Save the unit's settings onto the personal computer.

When the destination dialog box appears after clicking the [Execute] button, specify the destination folder.

When [Camera] is selected in [Config data type], the following settings are saved.

- Scene Scene1 settings
- Scene Scene2 settings
- Scene Scene3 settings
- Scene Scene4 settings
- System settings
- Preset settings

<NOTE>

- After the [Execute] button is clicked, the amount of time it takes for the destination dialog box to appear is about 10 seconds for a camera settings file and about 20 seconds for a network settings file.

Upload

The unit's setting files, which were saved in the personal computer by the download function, are uploaded.

Click the [Browse] button to display the dialog box, and specify the saved file.

When you click the [OK] button in the message dialog box that appears after you click the [Execute] button, uploading starts.

Another message dialog box appears after uploading is complete. When you click the [OK] button, the unit will restart automatically.

<NOTE>

- Use the files downloaded by the unit as the data to be used for uploading.
 - Do not change the extension of the files which have been downloaded.
- Do not turn off the unit's power while downloading or uploading is underway.
- Do not attempt to perform any operations while downloading or uploading is underway. Instead, wait until the downloading or uploading is completed.
- It takes about 2 minutes for the upload complete dialog box to appear for camera settings files.

Displaying the web screen using a mobile terminal

Connect the mobile terminal to the unit, and display the unit's images (MJPEG format only). Refreshing to the latest images takes place automatically.

Operations such as panning, tilting and zooming can also be performed from the mobile terminal.

The following models are supported as mobile terminals. (as of August 2014).

Mobile terminal	Specifications
iPad iPhone iPod touch	iOS 7.1
Android™ terminals	Android 4.3

<NOTE>

- For the latest information on compatible operating systems and web browsers, visit the support desk at the following website.
<https://pro-av.panasonic.net/>
- Use a standard web browser with an Android terminal.
- Images are displayed only in the JPEG format when using the standard web browser of an Android terminal.
- When the authentication dialog box is displayed, input the user name and password.

The default settings for the user name and password are as follows.

User name	admin
Password	12345

In order to ensure security, the password for the user name of "admin" must be changed without fail. (→ page 87)

- The buttons listed below are not displayed when "On" has been selected as the "User auth." (→ page 87) setting and "3. Live only" has been selected as the access level setting.

-Pan/Tilt

-Zoom

-Preset

-Iris

-Focus

-Camera menu (OSD menu) operation

- If the mobile terminal does not support the character code UTF-8, the characters cannot be displayed properly.
- When multiple Android terminals are connected to the unit at the same time, operation may become unstable.

1. Input "http://IP address/mobile/" *1 using the mobile terminal, and press the enter button.





The unit's images will now be displayed.

- *1 This IP address is the global IP address for the WAN of the router that enables internet access. However, it is the local IP address if the unit in the same LAN is to be accessed using a mobile terminal which supports a wireless connection.

Pan/Tilt 



When this button is pressed, the buttons for performing the pan/tilt operations are displayed on the screen.



	The camera is panned toward the left.
	The camera is tilted upward.
	The camera is tilted downward.
	The camera is panned toward the right.

<NOTE>

- The camera will not move diagonally even when the pan button and tilt buttons are pressed at the same time. (The button pressed first takes precedence.)

Zoom

The unit's zooming operations are performed using these buttons.

	Use this to adjust the zoom (magnification) in the Wide direction.
	Use this to adjust the zoom (magnification) to 1.0x.
	Use this to adjust the zoom (magnification) in the Tele direction.

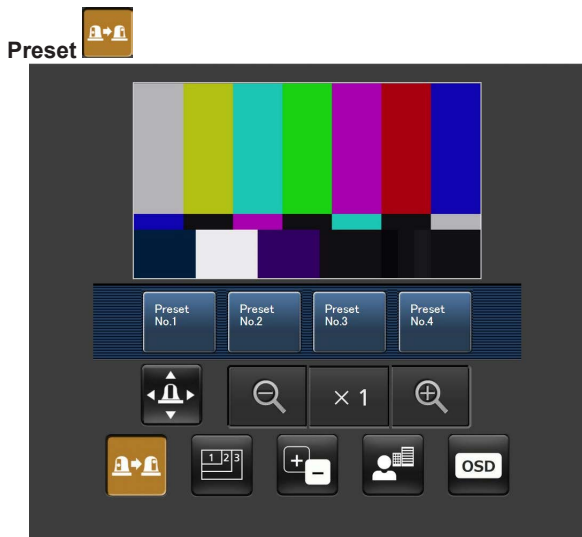

When this button is pressed, the buttons for selecting the preset positions are displayed on the screen.

	When one of the displayed buttons is pressed, the camera's pan/tilt position moves to the preset position that was registered ahead of time.
	The settings that are reproduced at this position are the settings which were established on the [Preset Scope] menu (→ page 56, page 82, page 84).

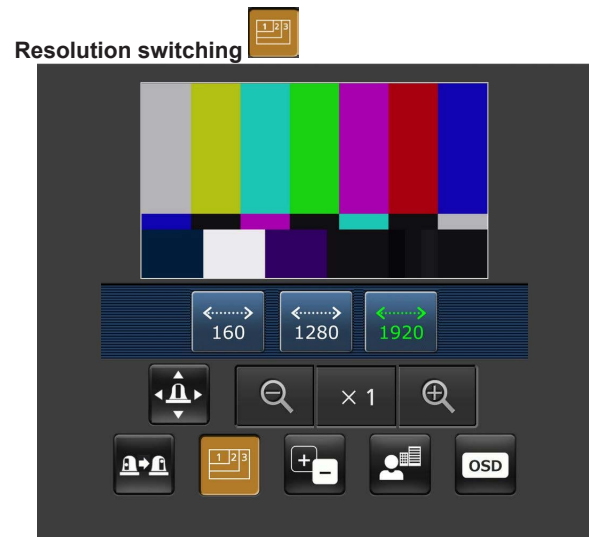

When this button is pressed, the buttons for selecting the resolution are displayed on the screen.

The characters are displayed in green for the resolution button which is currently selected.

The resolution configured with [JPEG(1)], [JPEG(2)], and [JPEG(3)] in the [Video over IP] tab is displayed.



	The images are displayed with a resolution of 1920 x 1080 pixels.
	The images are displayed with a resolution of 1280 x 720 pixels.
	The images are displayed with a resolution of 640 x 360 pixels.
	The images are displayed with a resolution of 320 x 180 pixels.
	The images are displayed with a resolution of 160 x 90 pixels.

<NOTE>

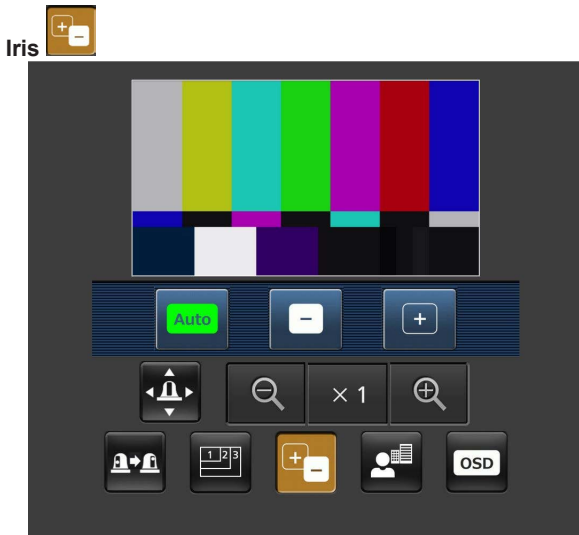
- Depending on the resolution set for [JPEG(1)], [JPEG(2)], and [JPEG(3)], resolution switching may not be possible.





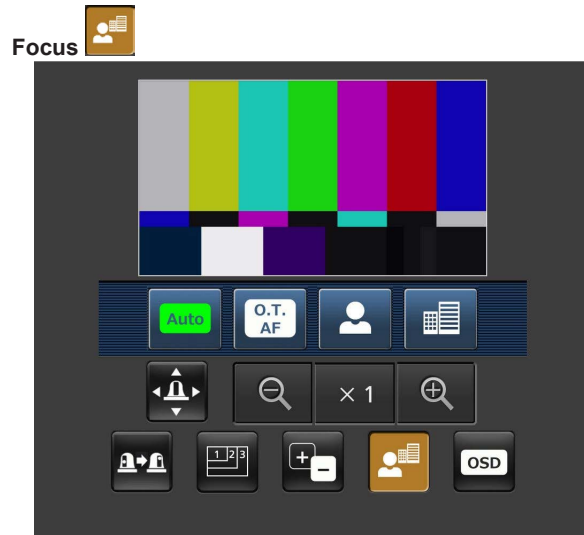

When this button is pressed, the buttons for performing the iris operations are displayed on the screen.

	This switches the iris between auto and manual. At the auto setting, the button label is green.
	This adjusts the iris in the “close” direction. It does not work during automatic adjustments.
	This adjusts the iris in the “open” direction. It does not work during automatic adjustments.



When this button is pressed, the buttons for performing the focusing operations are displayed on the screen.

	Use this to switch between auto and manual focusing. At the auto setting, focusing is performed (the focal point is adjusted) automatically. At the auto setting, the button label turns green.
	When this is pressed while the focus is being adjusted manually, the focus will be temporarily adjusted automatically. It does not work during automatic adjustments.
	Use this to adjust the focus in the Near direction. It does not work during automatic adjustments.
	Use this to adjust the focus in the Far direction. It does not work during automatic adjustments.

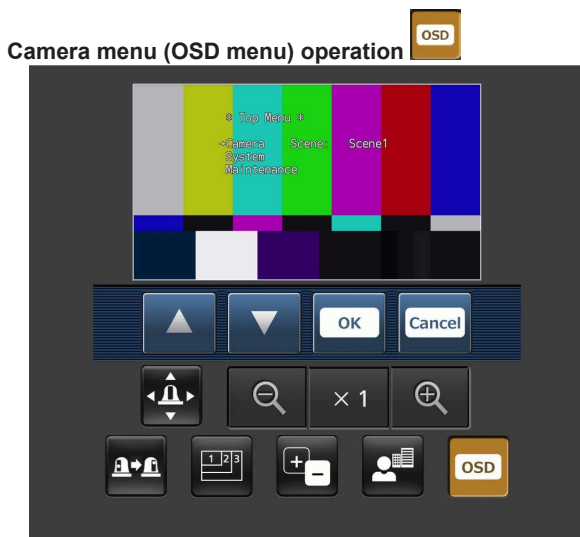

When this button is pressed, the buttons for performing the camera menu operations are displayed on the screen. At the same time, the camera menus are displayed on the unit's images.

	<p>The unit's camera menu operations can be performed by pressing the , , , and buttons. When any of these buttons is pressed to switch to an operation that does not involve a camera menu, the camera menus are no longer displayed on the unit's images. For details of the camera menu, refer to (→ page 60).</p>

Tally lamp lighting status displays

The lighting status of the camera's tally lamp is monitored at regular intervals while the camera is connected, and the lamp's display is updated.

While the tally lamp is on, the IP video display area frame turns red. When the tally lamp is off, the display area will return to normal.

<NOTE>

- It may take 2 seconds or so for a change in the lighting status of the tally lamp to be reflected on the display of the mobile terminal.
- When [Disable] is selected for [Tally] (→page 57, page 85), the camera's tally lamp will not light even when the tally signal is input. However, the tally lamp lighting status display will turn red.

<NOTE>

- If the HTTP port number has been changed from "80", enter "http://<IP address>:<port number>/mobile"*1 to specify the unit's port number.
- When [HTTPS] - [Connection] (→ page 93) is set to [HTTPS] in the [Advanced] tab of the Network setup screen [Network], enter the following.
https://<IP address port number>/mobile
- When the authentication dialog box appears, enter the user name and password of an administrator or general user. Depending on the mobile terminal, password entry may be required when transitioning between each screen.
- Audio cannot be received on mobile terminals.
- If the [User auth.] (→ page 87) setting has been changed to [On] from a personal computer while the mobile terminal screen is displayed, it may not be possible to refresh the mobile terminal screen. In a case like this, first close the web browser which is running on the mobile terminal, and then open the mobile terminal screen again.
- If the images are large, it may not be possible to display them on some mobile terminals. In a case like this, it may be possible to display the images if a setting close to low image quality is selected for [Image quality] (→ page 73) of the [JPEG] among the "Video over IP".
- Access may not be possible depending on your mobile terminal and device plans.
- If, when using an Android terminal, more than one button is pressed at the same time, one of the buttons may remain pressed even after it has been released. At a time like this, press again only that button that has remained pressed to release it.

Example) When the pan (left) button and pan (right) button are pressed at the same time, either the pan (left) button or pan (right) button will remain pressed, and panning will continue.

→ When the pan (left) button or pan (right) button that has remained pressed is pressed again, the panning will stop.

*1 This IP address is the global IP address for the WAN of the router that enables internet access. However, it is the local IP address if the unit in the same LAN is to be accessed using a mobile terminal which supports a wireless connection.

System log displays

NTP-related error displays

Category	Display	Description
Connection error	No response from the NTP server.	<ul style="list-style-type: none">The IP address of the server may be incorrect. Check the server's IP address settings again.The NTP server may be down. Consult your server administrator.
Internal error	Undefined error.	<ul style="list-style-type: none">A problem has occurred in the NTP function. Check the NTP settings again.
Successful NTP-based time synchronization	NTP update succeeded.	<ul style="list-style-type: none">The time has been updated successfully.

HTTPS-related log displays

Category	Display	Description
HTTPS	Self-signed Certificate - Generated	<ul style="list-style-type: none">Generation of the self-signed certificate is complete.
	Self-signed Certificate - Deleted	<ul style="list-style-type: none">Deletion of the self-signed certificate is complete.
	Certificate Signing Request - Generated	<ul style="list-style-type: none">Generation of the certificate signing request is complete.
	CA Certificate - Installed	<ul style="list-style-type: none">Installation of the server certificate is complete.
	CA Certificate - Deleted	<ul style="list-style-type: none">Deletion of the server certificate is complete.
	Previous CRT key - Applied	<ul style="list-style-type: none">The previous CRT key has been applied as the CRT key.
	Previous CRT key - Applied	<ul style="list-style-type: none">Generation of the CRT key is complete.

Login-related displays

Category	Display	Description
Login	(User name or IP address)	<ul style="list-style-type: none">If user authorization has been set, the name of the user who has logged onto the unit is displayed.If host authorization has been set, the IP address of the user who has logged onto the unit is displayed.

Displays related to access commands

Category	Display	Description
Image transmission demand	jpeg ch [No.] Play [User name] and [IP address]	<ul style="list-style-type: none">Displays the user name and IP address of the user that logged into this unit and made a JPEG transmission play demand.
	jpeg Stop [User name] and [IP address]	<ul style="list-style-type: none">Displays the user name and IP address of the user that logged into this unit and made a JPEG transmission stop demand.
	mjpeg ch [No.] Play [User name] and [IP address]	<ul style="list-style-type: none">Displays the user name and IP address of the user that logged into this unit and made a MJPEG transmission play demand.
	h264 ch [No.] Play [User name] and [IP address]	<ul style="list-style-type: none">Displays the user name and IP address of the user that logged into this unit and made a h264 transmission play demand.
	h264 ch [No.] Stop [User name] and [IP address]	<ul style="list-style-type: none">Displays the user name and IP address of the user that logged into this unit and made a h264 transmission stop demand.
Audio transmission demand	audio Play [User name] and [IP address]	<ul style="list-style-type: none">Displays the user name and IP address of the user that logged into this unit and made an audio transmission play demand.
	audio Stop [User name] and [IP address]	<ul style="list-style-type: none">Displays the user name and IP address of the user that logged into this unit and made an audio transmission stop demand.
Other CGI commands	[CGI command], [User name] and [IP address]	<ul style="list-style-type: none">Displays the user name and IP address of the user that logged into this unit and ran a specific CGI command. However, not all CGI commands are displayed each time they are executed.

Limiters

This unit comes with settings (referred to as “limiters”) that restrict the panning and tilting movement ranges.

Depending on the installation location, obstacles that may come into contact with the remote camera may exist within its movement range. In such cases, setting the limiters before the obstacles will prevent contact.

The positions of four limiters — namely, the upper, lower, leftmost and right-most limits of the travel range — can be set. Once they have been set, the positions will not be lost even after the power has been turned off.

The limiters can be set or released both by the wireless remote control and controller or web setting screen [Setup]. Whatever was set or released last takes precedence. For the controller operations, refer to the Operating Instructions of the controller.

The settings of the limiters using the wireless remote control will be described here.

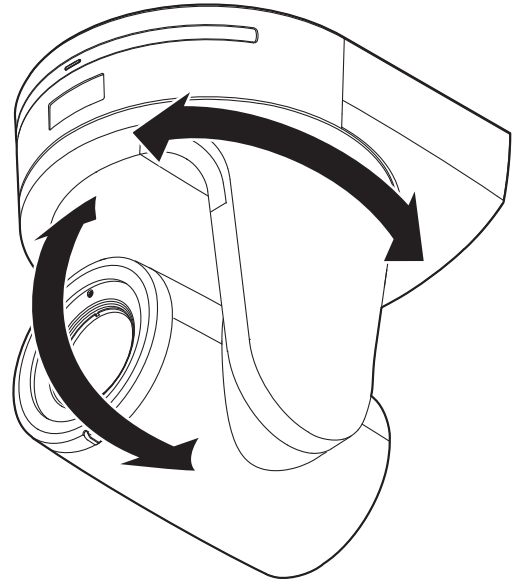

Setting/releasing the limiters

Setting/releasing the limiters

1. Press the <MENU> button.

Tap the button (rather than pressing it). When it is pressed for 2 seconds, the camera menu will appear. If this happens, press the <MENU> button again for 2 seconds to clear the camera menu.

Then start again from step 1.

2. Press the <▲ / ▼ / ◀ / ▶> button for 2 seconds while holding down the <PRESET> button.

The limiter for the upper limit, lower limit, left limit or right limit is set (or released) using these direction buttons, respectively. The tally lamp will blink at this time. When a limiter is set, it blinks once; when a limiter is released, it blinks twice.

If any other button was operated between steps 1 and 2, start again from step 1.

Setting the limiters

The limiter positions can be set by following the steps below. When the position is set, the tally lamp blinks once.

1. Press one of the <CAM1> to <CAM4> button to select the unit.

• Setting the upper limit position of the movement range

Press the <▲> or <▼> button of the wireless remote control to turn the unit as far as the position which will serve as the upper limit.

Next, perform the steps in “Basic limiter operations”.
(Press the <MENU> button quickly and then press the <▲> button for 2 seconds while holding down the <PRESET> button.)

• Setting the lower limit position of the movement range

Press the <▲> or <▼> button of the wireless remote control to turn the unit as far as the position which will serve as the lower limit.

Next, perform the steps in “Basic limiter operations”.
(Press the <MENU> button quickly and then press the <▼> button for 2 seconds while holding down the <PRESET> button.)

• Setting the left-most limit position of the movement range

Press the <◀> or <▶> button of the wireless remote control to turn the unit as far as the position which will serve as the left-most limit.

Next, perform the steps in “Basic limiter operations”.
(Press the <MENU> button quickly and then press the <◀> button for 2 seconds while holding down the <PRESET> button.)

• Setting the right-most limit position of the movement range

Press the <◀> or <▶> button of the wireless remote control to turn the unit as far as the position which will serve as the right-most limit.

Next, perform the steps in “Basic limiter operations”.
(Press the <MENU> button quickly and then press the <▶> button for 2 seconds while holding down the <PRESET> button.)

Releasing the limiters

The limiter positions that are set can be released by following the steps below.

When the position is released, the tally lamp blinks twice.

1. Press one of the <CAM1> to <CAM4> button to select the unit.

2. Release the limiters by taking the steps below.

• Releasing the upper limit position of the movement range

Perform the steps in “Basic limiter operations”.
(Press the <MENU> button quickly and then press the <▲> button for 2 seconds while holding down the <PRESET> button.)

• Releasing the lower limit position of the movement range

Perform the steps in “Basic limiter operations”.
(Press the <MENU> button quickly and then press the <▼> button for 2 seconds while holding down the <PRESET> button.)

• Releasing the left-most limit position of the movement range

Perform the steps in “Basic limiter operations”.
(Press the <MENU> button quickly and then press the <◀> button for 2 seconds while holding down the <PRESET> button.)

• Releasing the right-most limit position of the movement range

Perform the steps in “Basic limiter operations”.
(Press the <MENU> button quickly and then press the <▶> button for 2 seconds while holding down the <PRESET> button.)

Resetting the limiters

To reset the limiters, the currently established settings must be released. The limiter positions that are set can be reset by following the steps below.

1. Release the settings of the limiter positions to be reset by following the steps in “Releasing the limiters”.

2. Set the limiter positions by following the steps in “Setting the limiters”.

Safe mode

Concerning the safe mode

The unit goes into the safe mode when the pan-tilt head is forcibly moved by an external force or when something impedes its rotation. Once the safe mode has been established, some or all of the operations will no longer be acknowledged to ensure safety and prevent equipment damage.

Detection of equipment trouble

When the unit has detected trouble, its functions are shut down, then the unit is restarted or the initial setting operation is performed, and the normal condition of the unit is restored after about 30 seconds.

<NOTE>

- When trouble is detected, pictures may no longer be output for a while, but they will be restored in 5 seconds to 10 seconds.

Troubleshooting

■ Operation

Symptom	Cause and solution	Reference pages
No power	<ul style="list-style-type: none"> • Is the AC adaptor securely connected to the AC outlet? 	---
	<ul style="list-style-type: none"> • If the power plug of the AC adaptor connected properly? 	---
	<ul style="list-style-type: none"> • Is the LAN cable connected securely to the IP control LAN connector <LINK/ACT> ? 	page 18
	<ul style="list-style-type: none"> • Is the network cable for the PoE+ (IEEE802.at) compatible power supply device and the unit connected properly? 	Installation Instructions
	<ul style="list-style-type: none"> • Power may not be supplied if the total power limit is exceeded on power supply devices that allow connections to multiple PoE+ terminals. → Refer to the operating instructions for the PoE+ power supply device. 	---
	<ul style="list-style-type: none"> • If the unit is connected to the controller, has it been connected properly? → Refer to the operating instructions for the controller. 	Installation Instructions
	<ul style="list-style-type: none"> • When performing operations from a wireless remote control → Also refer to the "Cannot operate using the wireless remote control" item. 	---
Cannot operate (common to wireless remote control, controller)	<ul style="list-style-type: none"> • Is the power on? → If the unit's status display lamp is off or lights up orange, it means that the unit's power is not on. 	page 25
	<ul style="list-style-type: none"> • The safe mode function may have been activated. 	page 111
	<ul style="list-style-type: none"> • Have the limiter functions been set? 	pages 109 to 110
	<ul style="list-style-type: none"> • Has the unit you want to operate been selected properly? 	page 26
Cannot operate using the wireless remote control	<ul style="list-style-type: none"> • Have the remote control's batteries run down or have the batteries been installed with their polarities reversed? → If the status display lamp does not blink even when the wireless remote control is operated near the wireless remote control signal light-sensing area, it means that the batteries have run down. Replace the batteries. 	---
	<ul style="list-style-type: none"> • Have the IR ID switches been set correctly? 	page 18, page 22
	<ul style="list-style-type: none"> • Is there a fluorescent light or plasma monitor near the unit and, if so, is the wireless remote control signal light-sensing area exposed to its light? 	page 16
Cannot operate using the controller	<ul style="list-style-type: none"> • Is the unit connected to the controller properly? → Refer to the operating instructions for the controller. 	Installation Instructions
	<ul style="list-style-type: none"> • The user authorization and host authorization must be set to OFF when the AW-RP120, AW-RP50 and AK-HRP200 remote camera controllers are connected in a network. 	page 87, page 88
	<ul style="list-style-type: none"> • It may be necessary to upgrade the version of the controller so that the controller will support the unit. → For details on upgrading, visit the support page on the following website. https://pro-av.panasonic.net/ 	---
	<ul style="list-style-type: none"> • When using an HTTPS connection, network connection with the AW-RP50, AW-RP120, and AK-HRP200 will be disabled. 	page 93, page 98
The unit turns in the opposite direction to the one operated	<ul style="list-style-type: none"> • Has the stand-alone (Desktop) installation setting been selected correctly? 	page 56, page 84
	<ul style="list-style-type: none"> • The reversal setting may have been established at the controller if the unit is connected to the controller. → Refer to the operating instructions for the controller. 	---

Troubleshooting (continued)

Symptom	Cause and solution	Reference pages
Cannot access from a web browser	<ul style="list-style-type: none"> • Has a LAN cable of category 5 or above been connected to the LAN connector for IP control <LINK/ACT>? 	Installation Instructions
	<ul style="list-style-type: none"> • Is the <LINK> LED of the LAN connector for IP control <LINK/ACT> lit? → If it is not lit, it means that something is wrong with the connection to the LAN or that the network at the connection destination is not working properly. Check the LAN cable for defective contacts, and check the wiring. 	Installation Instructions
	<ul style="list-style-type: none"> • Is the power on? → If the unit's status display lamp is off or lights up orange, it means that the unit's power is not on. 	page 25
	<ul style="list-style-type: none"> • Has a valid IP address been set in the unit? 	page 88
	<ul style="list-style-type: none"> • Has the wrong IP address been accessed? → Check the connections by following the steps below. For Windows: Using the Windows command prompt, execute > ping [IP address which has been set in the camera] A reply returned from the unit signifies that there are no problems in operation. If a reply is not received, try following operation: • Reboot the unit, and within 20 minutes change the IP address using the Easy IP Setup Software. For Mac: Using the OS X terminal, execute > ping -c 10 [IP address which has been set in the camera] A reply returned from the unit signifies that there are no problems in operation. If a reply is not received, try following operation: • Reboot the unit, and within 20 minutes change the IP address using the Easy IP Setup Software. 	---
	<ul style="list-style-type: none"> • Are you accessing via "http://" while the HTTPS function is enabled? → Perform access via "https://" when using the HTTPS function. Entry of the port number is also required. 	page 98
	<ul style="list-style-type: none"> • Is the same IP address setting being used by another unit? → Check out the IP addresses of the unit, access devices (personal computer, mobile terminal, controller, etc.) and any other cameras. 	page 59
	<ul style="list-style-type: none"> • Does the subnet mask setting match the network subnet of the connection destination? → Check out the subnet mask settings of the unit and access devices, and then consult with the network administrator. 	page 59
	<ul style="list-style-type: none"> • Has the "Use a proxy server" setting been selected by the web browser? (When the unit and the personal computer are connected to the same subnet) → If a proxy server has been set using the [proxy setting] of the web browser, it is recommended that a "Don't use proxy" address be selected as the unit's IP address setting. 	---
<ul style="list-style-type: none"> • Has the wrong default gateway been set for the unit? (When the unit and personal computer are connected to different subnets) → Check out the default gateway that has been set for the unit, and then consult with the network administrator. 	page 59	

Troubleshooting (continued)

Symptom	Cause and solution	Reference pages
The settings on the web setting screen [Setup] are not updated or displayed properly	For Windows: <ul style="list-style-type: none"> Press the [F5] key on the keyboard of the personal computer to request that the settings be acquired. For Mac: <ul style="list-style-type: none"> Press the [Command] + [R] key on the personal computer's keyboard to request that the settings be acquired. 	---
	<ul style="list-style-type: none"> Perform the following to delete the temporary Internet files. For Windows: <ol style="list-style-type: none"> Select [Tools] - [Internet Options] in Internet Explorer. Click the [General] tab, and click the [Delete] button under [Browsing history]. In the [Delete Browsing History] screen, select the [Temporary Internet Files] checkbox, and then click [Delete]. Click the [OK] button. For Mac: <ol style="list-style-type: none"> Select [Safari] - [Empty Cache] in Safari. Click [Empty] in the [Are you sure you want to empty the cache?] pop-up screen. 	---
	For Windows: <ul style="list-style-type: none"> If [Check for newer versions of stored pages] is not set to [Every time I visit the webpage] in the temporary Internet file settings, IP images may not appear in the web setting screen. <ul style="list-style-type: none"> Perform the following. <ol style="list-style-type: none"> Select [Tools] - [Internet Options] in Internet Explorer. Click the [General] tab, and click the [Settings] button under [Browsing history]. In the [Temporary Internet Files and History Settings] dialog box, select the [Every time I visit the webpage] option under [Check for newer versions of stored pages]. Click the [OK] button. 	---
	<ul style="list-style-type: none"> The unit's ports may be filtered by the firewall or other function of the anti-virus software. <ul style="list-style-type: none"> Change the HTTP port number of the unit to a port number that will not be filtered. 	---
It is not possible to download the setting files	For Windows: <ul style="list-style-type: none"> Has the file download function been disabled? <ul style="list-style-type: none"> Perform the following. <ol style="list-style-type: none"> Select [Tools] - [Internet Options] in Internet Explorer. Click the [Security] tab, and click the [Custom level] button under [Security level for this zone]. In the [Security Settings] dialog box, select the [Enable] option for [File download]. For Internet Explorer 8 only: <ul style="list-style-type: none"> Select the [Enable] option for [Automatic prompting for the file downloads]. Click the [OK] button. Click the [OK] button. 	---
The tally lamps do not light	<ul style="list-style-type: none"> Is the [Tally] setting set to [Disable]? <ul style="list-style-type: none"> If [Tally] is set to [Disable], the unit's tally lamp does not light. Change the setting to [Enable]. 	---
Status lamp does not light	<ul style="list-style-type: none"> Is the [Status Lamp] setting set to [Disable]? <ul style="list-style-type: none"> If [Status Lamp] is set to [Disable], the status lamp does not light when this unit is working properly. Change the setting to [Enable]. 	P.57, P.85
Commands from the personal computer, external devices, and remote controller are unstable	<ul style="list-style-type: none"> Are two or more Android terminals connected? <ul style="list-style-type: none"> Only one Android terminal can be connected to the unit. 	---
The authentication screen appears repeatedly	<ul style="list-style-type: none"> Has the user name or password been changed? <ul style="list-style-type: none"> If you change the user name and password of the user currently logged in from a separate web browser while the unit is being accessed, the authentication screen appears each time the screen display is changed. Close the web browser, and initiate access to the unit again. 	page 87, page 88
	<ul style="list-style-type: none"> Has the method for user authentication been changed? <ul style="list-style-type: none"> If you change the [User auth.] - [Authentication] setting, close the web browser and initiate access again. 	page 87

Troubleshooting (continued)

Symptom	Cause and solution	Reference pages
Screens displays take a while to appear	<ul style="list-style-type: none"> • Is access being performed in HTTPS mode? Screen displays may take a while to appear in HTTPS mode due to signal processing. 	---
	<ul style="list-style-type: none"> • Is the unit on the same local network and being accessed via proxy? → Configure the web browser settings so that access is not performed via proxy. 	---
	<ul style="list-style-type: none"> • Are multiple users accessing the unit's IP images at the same time? → When multiple users access the unit's IP images at the same time, images may take some time to appear, and the frame rate of the IP images may drop. 	---
Cannot access the camera from a mobile terminal	<ul style="list-style-type: none"> • Is the URL correct? Has "/mobile" been entered at the end of the URL? → Check whether the URL has been entered correctly. When accessing the unit from a mobile terminal, "/mobile" must be added to the end of the URL used to access the unit from a personal computer. 	page 104
	<ul style="list-style-type: none"> • Is the HTTPS SSL encryption of the mobile terminal different from that of the unit? → Set [HTTPS] - [Connection] for the unit to [HTTP], and initiate access again. 	page 93
	<ul style="list-style-type: none"> • Are you accessing via "http://" while using the HTTPS function? → When using the HTTPS function, access via "https://". Port number entry is also necessary. 	page 107
The shortcut icon of the camera does not appear under [Network] on the personal computer	<ul style="list-style-type: none"> • Has the Windows UPnP component been added? → Add the Windows UPnP component to the personal computer you are using. 	page 92

Troubleshooting (continued)

■ Video

Symptom	Cause and solution	Reference pages
No pictures are displayed or the pictures are disturbed	• Has the unit been connected properly to the other connected devices?	Installation Instructions
	• If the system is configured in such a way that the picture is also switched when the unit to be operated is selected, has the correct unit been selected?	page 26
	• Has the image signal setting been selected correctly?	page 54, page 84
	• Are external sync signals that are supported by the video signal format which has been set being input?	page 18
The picture is flipped vertically	• Has the stand-alone (Desktop) installation setting been selected correctly?	page 56, page 84
Multiple color bands (color bars) are displayed	• Switch to the camera picture.	page 29
The menu screen is displayed	• Exit the camera menu.	page 37 to page 45
It is difficult to view the menu screens	<ul style="list-style-type: none"> • Depending on the HDMI monitor you are using, you may experience one or more of the symptoms described below. These symptoms are especially noticeable when any of the SD formats is used: This is normal and not indicative of any trouble. • The resolution of the characters in the camera menu displays changes as the background image changes. • Depending on the edge enhancement setting established for the monitor, white lines appear in front of the black shadows of the camera menus. • Depending on the edge enhancement setting established for the monitor, the background colors may be superimposed onto the white parts of the camera menus. 	---
No auto focusing	<ul style="list-style-type: none"> • Is the focus set to manual? → Auto focusing is initiated as soon as the focus is set to auto. 	page 29
	<ul style="list-style-type: none"> • In some situations, it may be hard to focus at the auto setting. → In cases like this, select the manual setting, and focus manually. 	page 30
The subject is not brought into focus during zooming when the manual setting is used for the focus	<ul style="list-style-type: none"> • Was the focus adjusted at the Tele end? → First adjust the focus at the Tele end where the focusing accuracy is higher, and then proceed with the zooming. 	---
	<ul style="list-style-type: none"> • Under some operating conditions, it may be hard to bring subjects into focus. → In such cases, use the focus at the auto setting. 	page 29
Focusing is not possible in night mode	<ul style="list-style-type: none"> • Are you shooting with visible light? → The focus position is different due to the difference in refractive index between visible light and infrared light. Wavelengths near 900 nm are assumed for infrared light in night mode on this unit. Perform manual adjustment if necessary. 	page 30
1080/59.94p images are not output	<ul style="list-style-type: none"> • Is the format set to 59.94p? → Configure the format setting. 	page 56, page 84
1080/50p images are not output	<ul style="list-style-type: none"> • Is the format set to 50p? → Configure the format setting. 	page 56, page 84
1080/29.97PsF images appear jerky	<ul style="list-style-type: none"> • This is normal operation. → In the PsF (Progressive segmented Frame) format, an identical image is captured to fields 1 and 2 in order to output the same image as progressive. Therefore, the image will appear slightly jerky. 	---
1080/25PsF images appear jerky	<ul style="list-style-type: none"> • This is normal operation. → In the PsF (Progressive segmented Frame) format, an identical image is captured to fields 1 and 2 in order to output the same image as progressive. Therefore, the image will appear slightly jerky. 	---

Troubleshooting (continued)

Symptom	Cause and solution	Reference pages
Something is wrong with the coloring of the pictures	<ul style="list-style-type: none"> • Activate the ATW (Auto tracking white adjustment) function. 	page 33
	<ul style="list-style-type: none"> • In some situations, the proper colors may not be reproduced using the ATW function. → In cases like this, proceed with the white balance adjustment. 	pages 32 to 33
The pictures are too light or too dark	<ul style="list-style-type: none"> • Either select the auto setting for the iris or select the manual setting and adjust the iris manually. 	page 30
	<ul style="list-style-type: none"> • The pictures may be dark if the analog video signal cables are too long because this will cause signal attenuation. 	---
Images are in black and white	<ul style="list-style-type: none"> • Is the unit in night mode? → In night mode, output will be in black and white. 	page 48, page 78
Auto white balance adjustment (AWB) is not possible	<ul style="list-style-type: none"> • Is the unit in night mode? → Auto white balance adjustment (AWB) is not possible in night mode. 	page 48, page 78
The screen is too bright in night mode	<ul style="list-style-type: none"> • The aperture is set to open in night mode to prevent video voyeurism. Adjust the brightness at the light source. 	page 30
The iris does not operate in night mode.		
The subjects appear distorted	<ul style="list-style-type: none"> • Since this camera uses an MOS imaging device, the pickup timing differs slightly at the top left and bottom right of the screen. This means that if a subject moves quickly across the front of the camera, it may appear slightly distorted. This is not a malfunction. 	---
When the flash is fired during shooting, only the top or bottom of the screen becomes lighter	<ul style="list-style-type: none"> • With a MOS imaging sensor, the pickup timing differs slightly at the top left and bottom right of the screen. This means that when the flash is fired, the bottom of the screen will become lighter in the field concerned and the top will become lighter in the next field. This is normal and not indicative of any problem. 	---
The brightness changes cyclically or the colors change, and horizontal stripes can be seen passing across the screen	<ul style="list-style-type: none"> • These phenomena (flicker) may occur under the illumination produced by fluorescent lighting, mercury bulbs or other types of discharge tubes. In such cases, we recommend setting the electronic shutter speed to 1/100 in regions with 50 Hz power supply frequency, and to OFF in regions with 60 Hz power supply frequency. 	---
When fine lines or cyclical patterns are shot, flickering is seen or coloring is added to them	<ul style="list-style-type: none"> • This phenomenon occurs because the pixels are arranged systematically on each image sensor. It is noticeable when the spatial frequency of a subject and the pixel pitch are brought into proximity so change the camera angle or take other action. 	---
Noise occurs in the audio input	<ul style="list-style-type: none"> • The following causes are possible. <ul style="list-style-type: none"> - The camera, switching hub, or peripheral devices are not grounded. - Power lines are running nearby. - Equipment generating strong electric or magnetic fields (e.g., television and radio antennas, air conditioning motors, power transformers) are located nearby. <p>If the problem cannot be resolved via movement of surrounding devices, use a microphone equipped with an amplifier, or connect an audio output with low output impedance.</p>	page 7

■ IP images

Symptom	Cause and solution	Reference pages
Images are not displayed	For Windows: <ul style="list-style-type: none"> • Is the plug-in viewer software installed? → Install the plug-in viewer software. 	page 24
	For Windows: <ul style="list-style-type: none"> • If [Check for newer versions of stored pages] is not set to [Every time I visit the webpage] in the temporary Internet file settings, IP images may not appear in the live screen [Live]. → Perform the following. <ol style="list-style-type: none"> ① Select [Tools] - [Internet Options] in Internet Explorer. ② Click the [General] tab, and click the [Settings] button under [Browsing history]. ③ In the [Temporary Internet Files and History Settings] dialog box, select the [Every time I visit the webpage] option under [Check for newer versions of stored pages]. ④ Click the [OK] button. 	---
The images are blurry	<ul style="list-style-type: none"> • Is the focus properly adjusted? → Check the focus adjustment. 	---
Images are not updated	<ul style="list-style-type: none"> • The images may not be updated and other problems may occur depending on your web browser and its version. • The images may stop depending on the network congestion, the level of access to the unit, etc. • If the IP video settings of the unit were changed, the image display may stop temporarily. → Check the level of access to the unit, including the multi screen display, and stop any unnecessary access. Afterward, check the following. <ul style="list-style-type: none"> For Windows: Press the [F5] key on the personal computer's keyboard to request that the settings be acquired. For Mac: Press the [Command] + [R] key on the personal computer's keyboard to request that the settings be acquired. For mobile terminals: Refresh the screen by pressing the [Refresh] button on the web browser, for example, to request that the settings be acquired. 	---
The images do not update or display properly	<ul style="list-style-type: none"> • Perform the following to delete the temporary Internet files. <ul style="list-style-type: none"> For Windows: <ol style="list-style-type: none"> ① Select [Tools] - [Internet Options] in Internet Explorer. ② Click the [General] tab, and click the [Delete] button under [Browsing history]. ③ In the [Delete Browsing History] screen, select the [Temporary Internet Files] checkbox, and then click [Delete]. ④ Click the [OK] button. For Mac: <ol style="list-style-type: none"> ① Select [Safari] - [Empty Cache] in Safari. ② Click [Empty] in the [Are you sure you want to empty the cache?] pop-up screen. 	---
	<ul style="list-style-type: none"> • Reconfigure Wi-Fi settings as follows. <ul style="list-style-type: none"> For mobile terminals (iOS): Execute [Reset Network Settings] in [Settings] icon - [General] - [Reset], and configure new Wi-Fi settings. 	---
	<ul style="list-style-type: none"> • The unit's ports may be filtered by the firewall or other function of the anti-virus software. → Change the HTTP port number of the unit to a port number that will not be filtered. 	---
H.264 images are not displayed	<ul style="list-style-type: none"> • If the "Network Camera View 4S" plug-in viewer software is deleted in an environment where the "Network Camera View 3" plug-in viewer software is installed, display of H.264 images will become impossible. In such cases, delete "Network Camera View 3" before installing "Network Camera View 4S". 	---
	<ul style="list-style-type: none"> • Is the camera connected to the personal computer via the Internet? → Set [Internet Mode] to [On]. 	page 73

Troubleshooting (continued)

Symptom	Cause and solution	Reference pages
The images are distorted	<ul style="list-style-type: none"> • The images may be distorted if the transmission path is congested and proper transmission is not possible. → Consult your network administrator. 	---
	<ul style="list-style-type: none"> • The images may be distorted if video packet shuffling occurs on the transmission path. → Switching to an identical Internet service provider for both the camera and the personal computer may prevent this problem. Consult your network administrator. 	---
The images darken when the mobile terminal is not operated for a certain period	<ul style="list-style-type: none"> • Is the power-saving mode of the mobile terminal enabled? → Disable the power-saving mode of the mobile terminal to allow the images to be displayed indefinitely. 	---
When multiple web browsers are running to display H.264 images, images from multiple cameras appear sequentially in a single web browser.	<p>For Windows:</p> <ul style="list-style-type: none"> • This may occur depending on the combination of the personal computer's display adapter and the driver. → If this occurs, update the first display adapter to the latest version. If this does not resolve the problem, adjust the hardware accelerator function as follows. This section describes the procedure for Windows 7 as an example. Changing the settings may not be possible, depending on your environment. <ol style="list-style-type: none"> ① Right-click on the desktop, and select [Screen Resolution] from the menu. ② Click [Advanced settings]. ③ Select the [Troubleshoot] tab, and click [Change setting]. ④ If the [User Account Control] dialog box appears, click [Yes]. (When logged on with an account other than an administrator account, enter the password (and user name if necessary), and click [Yes].) ⑤ Change to [Hardware acceleration] setting to [None] at the far left, and click [OK]. 	---

Troubleshooting (continued)

■ Web screen

Depending on the OS installed on the personal computer, the following may occur. Follow the instructions below when the following has occurred. Performing the following solutions will not affect the operation of other applications.

For Windows:

The "information bar" described in the following explanations refers to the message bars that appear in Internet Explorer.

For Internet Explorer 9.0, 10.0, and 11.0:

The information bar appears at the bottom of Internet Explorer.

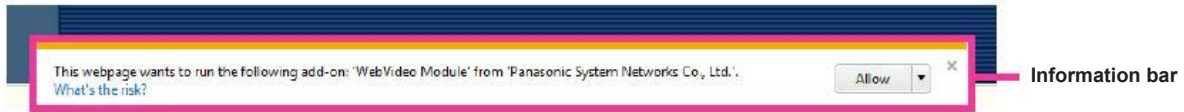

Information bar

For Internet Explorer 8.0:

The information bar appears under the address bar of Internet Explorer.

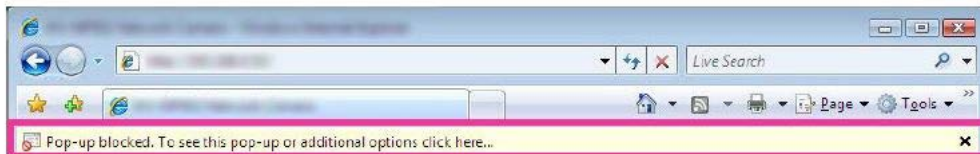

Information bar

Symptom	Cause and solution	Reference pages
For Internet Explorer 9.0, 10.0, and 11.0: The following message appears in the information bar. "This website wants to run the following add-on: 'WebVideo Module' from 'Panasonic System Networks Co.,Ltd.'."	<ul style="list-style-type: none"> Select [Allow]. 	---
For Internet Explorer 8.0: The following message appears in the information bar. "Pop-up blocked. To see this pop-up or additional options click here..."	<ul style="list-style-type: none"> Click the information bar, and select [Always Allow Pop-ups from This Site]. When the [Allow pop-ups from this site?] dialog box appears, click the [Yes] button. 	---
For Internet Explorer 9.0, 10.0, and 11.0: The following message appears in the information bar. "This website wants to install the following add-on: 'nwcV4SSetup.exe' from 'Panasonic System Networks Co.,Ltd.'."	<ul style="list-style-type: none"> Select [Install]. When the security warning window appears, click the [Install] button. 	---
For Internet Explorer 8.0: The following message appears in the information bar. "This site might require the following ActiveX control: 'nwcV4SSetup.exe' from 'Panasonic System Networks Co.,Ltd.'. Click here to install..."	<ul style="list-style-type: none"> Click the information bar, and select [Install ActiveX control]. When the security warning window appears, click the [Install] button. 	---
An unnecessary status bar or scroll bar is displayed on the pop-up window	<ul style="list-style-type: none"> Open the security settings screen for Internet Explorer, and select [Internet]. Click the [Custom level] button, set [Allow script-initiated windows without size or position constraints] to [Enable] under [Miscellaneous], and click the [OK] button. When the warning window appears, click the [Yes] button. 	---
The IP images do not match the display frames	<ul style="list-style-type: none"> Images may not appear correctly if their DPI settings are 120 DPI or higher. → Right-click on the desktop of the personal computer, click [Screen Resolution] - [Make text and other items larger or smaller], and select [Smaller - 100% (default)]. 	---
	<ul style="list-style-type: none"> Images may not appear correctly if the magnification level of Internet Explorer's zoom function is not set to 100%. → Select [View] - [Zoom] in the menu bar of Internet Explorer, and click [100%]. 	---
The layout of the screen is distorted, or some buttons on the screen do not operate	<ul style="list-style-type: none"> Select [Tools] - [Compatibility View Settings] in the menu bar of Internet Explorer, disable compatibility view for the unit. 	---

Specifications

Power requirements: 12 V DC (==) (AC adaptor supplied)
42 V - 57 V DC (==) (PoE+ power supply)
Current consumption: 1.8 A (AC adaptor supplied)
0.6 A (PoE+ power supply)

 indicates safety information.

■ GENERAL

Ambient operating temperature:

0 °C to 40 °C (32 °F to 104 °F)

Storage temperature:

-20 °C to 50 °C (-4 °F to 122 °F)

Allowable humidity ranges:

20 % to 90 % (no condensation)

Mass:

Approx. 3.1 kg (6.83 lb) [Including mount bracket]

Dimensions (W x H x D):

180 mm × 228 mm × 234 mm
(7-3/32 inches × 9 inches × 9-3/16 inches)
(excluding protrusions, cable cover, direct ceiling
mount bracket)

Finish:

AW-HE130WP/AW-HE130WE: Pearl white
AW-HE130KP/AW-HE130KE: Metallic black

Controller supported:

AW-RP120, AW-RP50, AK-HRP200
• It may be necessary to upgrade the version of the
controller in order to support the unit. For details on
upgrading, visit the support page on the following
website.
<https://pro-av.panasonic.net/>

■ INPUT

Input connector: DC 12 V IN,
G/L IN (BNC)

- BBS (Black Burst Sync), tri-level sync supported
- Locking to a color subcarrier is not possible with
BBS.

PoE+ (IEEE802.3at standard)

■ OUTPUT

Video output

HDMI:

HDMI connector
• HDCP is not supported.
• Viera Link is not supported.

HD/SD SDI OUT: SMPTE424/SMPTE292/SMPTE259 standards
75 Ω(BNC×1)

VIDEO OUT:

NTSC/PAL
1.0 V [p-p]/75 Ω (BNC×1)

■ INPUT/OUTPUT

Input/Output connector

LAN:

LAN connector for IP control (RJ-45)

RS-422:

CONTROL IN RS-422A (RJ-45)

MIC/LINE input: φ3.5 mm stereo mini jack

Input impedance: High impedance

- During MIC input
Supported mic: Stereo mic (plug-in power,
on/off switching via menu)
- Supply voltage: 2.5 V ± 0.5 V
Mic input sensitivity: Approx. -40 dBV ± 3 dBV
(0 dB=1 V/Pa, 1 kHz)
- During LINE input
Input level: Approx. -10 dBV ± 3 dBV

■ FUNCTIONS AND PERFORMANCE

[Camera unit]

Imaging sensors: 1/2.86-type Full-HD 3MOS

Lens:

Motorized 20 zoom, F1.6 to F3.4
(f=4.5 mm to 90 mm; 35 mm equivalent: 32.13 mm
to 642.5 mm)

Focus:

Switching between auto and manual

Focus distance:

Entire zooming range: 800 mm (2.62 ft)
Wide end: 400 mm (1.31 ft)

Color separation optical system:

3MOS

Minimum illumination:

2 lx(50 %, F1.6, 36 dB)

Horizontal resolution:

1000 TV lines Typ (Center area)

Gain selection:

Auto, 0 dB to 36 dB

Frame mix:

0 dB, 6 dB, 12 dB, 18 dB, 24 dB
• This cannot be configured when the format is
1080/29.97p, 1080/23.98p, 1080/29.97PsF,
1080/23.98PsF, 1080/25p, or 1080/25PsF.

Electronic shutter speed:

- 59.94p/59.94i:
1/100, 1/120, 1/250, 1/500, 1/1000, 1/2000,
1/4000, 1/10000
- 29.97p:
1/30, 1/60, 1/120, 1/250, 1/500, 1/1000, 1/2000,
1/4000, 1/10000
- 23.98p:
1/24, 1/60, 1/120, 1/250, 1/500, 1/1000, 1/2000,
1/4000, 1/10000
- 50p/50i:
1/60, 1/120, 1/250, 1/500, 1/1000, 1/2000, 1/4000,
1/10000
- 25p:
1/25, 1/60, 1/120, 1/250, 1/500, 1/1000, 1/2000,
1/4000, 1/10000

Synchro scan:

- 59.94 Hz:
60.15 Hz to 642.21 Hz
- 50 Hz:
50.15 Hz to 535.71 Hz

Gamma:

HD, SD, FILMLIKE1, FILMLIKE2, FILMLIKE3
0.30 to 0.75 (Manual setting)

White balance:

AWB A, AWB B, ATW, 3200K, 5600K, VAR (2000K
to 15000K)

Specifications (continued)

Chroma amount variability:

OFF, -99 % to 40 %

Scene file: Scene1, Scene2, Scene3, Scene4

Output format: 1080/59.94p, 1080/29.97p*¹, 1080/23.98p*³,
1080/59.94i, 1080/29.97PsF*³, 1080/23.98PsF,
720/59.94p, 480/59.94p(i)*², 1080/50p, 1080/25p*¹,
1080/50i, 1080/25PsF*⁴, 720/50p, 576/50p(i)*²

*¹ Native output

*² A 'P' signal is output as HDMI output, an 'I' signal is output as SDI and an analog output for output formats of 480/59.94p(i) and 576/50p(i).

*³ OVER 59.94i output (your monitor may recognize the signal as 59.94i).

*⁴ OVER 50i output (your monitor may recognize the signal as 50i).

Synchronization system:

Internal/External synchronization (BBS/Tri-level sync)

[Pan-tilt head unit]

Installation method:

Stand-alone (Desktop) or suspended (Hanging)

- To ensure safety, the unit must be secured using the mount bracket supplied.

Camera/pan-tilt head control:

IP connecting cable	<ul style="list-style-type: none">• When connecting through a hub: LAN cable*⁵ (category 5e or above, straight cable), max. 100 m (328 ft)• When a hub is not used: LAN cable*⁵ (category 5 or above, crossover cable) max. 100 m (328 ft)
RP connecting cable	LAN cable* ⁵ (category 5 or above, straight cable), max. 1000 m (3280 ft) RS-422A, AW series protocol

*⁵ Use of an STP (shielded twisted pair) cable is recommended.

Pan/tilt operation speed:

0.08°/s to 60°/s

Panning range: ±175°

Tilting range: -30° to 210°

- Depending on the pan or tilt position, the camera may be reflected in the image.

Quietness: NC35 or less

■ AC adaptor

Power source : 100 V - 240 V AC (⌚), 50 Hz/60 Hz, 1.2 A
Power output : 12 V DC (==), 3.0 A

 indicates safety information.

Inrush current, measured according to European standard EN55103-1, on initial switch-on: 4A, after a supply interruption of 5 s: 13 A

Index

Numerics

3200K	33
5600K	33

A

ABB	79
Access level	87, 88
Accessories	13
Activation	88
Advanced	91
AGC Max Gain	48, 77
Anti-theft wire mounting hole	18
ATW	33
Audio	57, 76
Audio bit rate	76
Audio button	68
Audio encoding format	76
AUDIO IN connector	18
Authentication	87
Automatic installation of viewer software	71
Auto port forwarding	92
AWB	32, 79

B

Back up	103
Bandwidth control (bit rate)	90
Basic	71
B Gain	49, 79
Black balance	34
Black level	35
B Pedestal	49, 79
Brightness	47, 48, 68, 77, 82
Buffering	71
Burst tolerance level	74

C

Cable clamp	18
CA Certificate	
CA Certificate install	93, 98
Generate Certificate Signing Request	93, 97
Information	93
CAM/BAR	66
Camera	46, 47
Camera head	17
Camera menu	39, 41, 46, 60, 107
Camera short cut	92
Camera title	71, 86
Camera title display area	71
Chroma Level	49, 79
Color Bars Setup	54, 84
Color Correction	51, 52, 81
COLOR TEMP	39, 41
Color temperature	39, 41
Color Temperature	49, 79
Common	90
Compression	66
Config data type	103
Connection	93, 98
Contact	94
Control pad and its buttons	68, 82
Control time period	74
CPU Software	
Camera Main	58, 101
Interface	58, 101
Network	58, 101
Servo	58, 101
CRT key generate	92, 96

D

Day/Night	48, 78
DC IN connector	18
Default gateway	89, 90
Default Gateway	59

Default reset	103
Description	101
Destination IP address (1)	88
Destination IP address (2)	88
Detail	49, 79
Detail Band	49, 79
D.EXTENDER	40
DHCPv6	90
Diffserv	94
Digital extender	40
Digital Extender	56, 85
Digital Zoom	56, 85
DNR	50, 80
DNS	89
Down CONV. Mode	54, 84
Download	103
Drop-prevention wire	17
DRS	49, 80
DSCP(0-63)	94

E

Easy IP Setup accommodate period	90
Easy IP Setup Software	23
EEPROM	
Interface	58, 101
End time & date	92
External sync signal input format	18

F

firmware	101
Firmware file	101
Firmware VER	58
Firmware version	101
Firmware Version	58
Flesh Tone Noise SUP	79
FleshTone NoiseSUP.	49
Flip Detect Angle	56, 84
Focus	30, 67, 82, 106
Focus ADJ With PTZ.	56, 82, 85
Focus Mode	56, 85
Format	54, 55, 84
FPGA	
AVIO	58, 101
Com	58, 101
Lens	58, 101
Frame Mix	48, 78
Frame rate	74
FREEZE DURING	40, 42
Freeze During Preset	56, 82, 85
Frequency	54, 55, 84
Full-screen display button	68

G

Gain	30, 48, 77
Gamma	49, 80
Gamma Type	49, 79
Genlock	36, 53, 83
G/L IN connector	18
Ground connector	18
Grounding	7

H

H.264(1) • H.264(2) • H.264(3) • H.264(4)	73
H.264 transmission	73
HDMI connector	18
HDMI Out	57, 85
Hole for securing the camera pedestal	17
Hole used to secure cable cover	18
Horizontal Phase	53, 83
Horizontal phase adjustment	36
Horizontal Phase Step	53
Host auth.	88
Host check	88
HTTP max segment size (MSS)	90

Index (continued)

HTTP port	90
HTTPS	92, 95, 98
HTTPS port	93

I

Image	72
Image adjust	76, 77
Image capture size	73
Image Capture Size	66
Image/Position	76
Image quality	66, 73, 74
Image quality (JPEG)	73
Initial display settings for "Live" page	72
initialization	59
Initialize	58
Input Volume	57
Install Position	56, 84
Internet mode (over HTTP)	73
IP	57, 85
IP address	86, 88
IP Address	59
IP address (IPv4)	89
IP address (IPv6)	90
IP Network	58, 59
IPv4 network	89
IPv6 network	90
IR ID switches	18, 22
Iris	30, 106
Iris Mode	47, 77

J

JPEG	73
JPEG transmission	73

K

Knee Mode	50, 80
Knee Point	50, 80
Knee Slope	50, 80

L

LAN connector for IP control	18
Limitation Setting	83
Limiters	109, 110
Linear Matrix	51, 81
Line speed	90
Live	64, 65, 69
Live screen	64
Multi display mode	69
Single display mode	65
Location	94

M

Main area	71
Maintenance	46, 58, 101
Manual	90
Manual shooting	30
Master Detail	49, 79
Master pedestal	35
Matrix	47, 50, 51, 52
Matrix Settings	80
Matrix Type	50, 81
Max bit rate (per client)	74
Max Digital Zoom	56, 85
Max RTP packet size	90
Mic input interval	76
Mic input volume	76
Mobile terminal	104
Model Select	85
Mount bracket for installation surface	17
Multicast address	75
Multicast port	75
Multicast TTL/HOP Limit	75

Multi-screen	66, 69
Multi-Screen setup	86

N

ND Filter	48, 78
Network	89
Network Settings	89
Night mode	39, 41
No	101
Noise Suppress	49, 79
NTP	91
NTP port	92
NTP server address	91
NTP server address setting	91

O

OIS	40, 42, 56, 85
Op. Lock	67
Optical image stabilization	40, 42
Optional accessories	13
OSD Menu Operation	66
OSD Mix	57, 85
OSD Off With Tally	57, 85
OSD Status	57, 85
Others	53, 56, 57, 84
Output	53, 54, 84

P

Pan	104
Password	87
Pedestal	49, 79
Phase	51, 52, 81
Picture	47, 49, 50, 78
Picture Level	47, 77
Plugin Power	57, 76
Plug-in viewer software	24
Port number (HTTP)	102
Port number (HTTPS)	102
Power	25
Power ON	67, 71
Preset	68, 81, 105
Preset D-Extender	56, 85
Preset memory	31
Preset position	76, 81
Preset Scope	56, 82, 84
Preset Setting	82
Preset Speed	56, 82, 84
PRESET SPEED	40, 41
Preset Speed Table	56, 84
Primary DNS server address	90
Primary server address	89
Priority stream	88
Product info.	101
Protocol Model Select	57

R

Reboot	103
Recommended network setting for internet	91
Refresh interval	74, 88
Refresh interval (JPEG)	73
Remote control IDs	22
Reset to the default (Except the network settings)	103
Resolution	105
Retype password	87
R Gain	49, 79
Router global address	102
R Pedestal	49, 79
RS-232C connectors	18
RS-422 connector	17
RTSP	94
RTSP port	94
RTSP Request URL	94

Index (continued)

S

Safe mode	111
Saturation	51, 52, 81
Scene	47, 68, 77
Scene file	27
SDI Out	57, 85
SDI OUT connector	18
Secondary DNS server address	90
Secondary server address	89
Security certificate	99
Self-signed Certificate	
Generate	93, 96
Information	93
Service switches	18
Setup	37, 64, 70
Shooting	25, 28
Shooting mode	27
Shutter Mode	47, 77
Shutter speed	30
Simultaneous output conditions	19
Smart Picture Flip	56, 84
Smoother live video display on the browser	71
Snapshot button	68
SNMP	93
SNMPv1/v2	
Community	93
SNMPv3	
Authentication	94
Encryption method	94
Password	94
User name	94
SNMP version	93
Speed	68, 82
Speed With Zoom POS.	56, 82, 85
Square holes for cable cover tabs	18
Standby	67, 71
Start time & date	92
Status	101, 102
Status display lamp	17
Status Lamp	57, 85
Step/Synchro	47
Stream	66, 72
Stream Type	88
Subnet Mask	59, 89
Summer time(daylight saving)	92
System	46, 53, 83
System log	101, 108
System name	94

T

Tally	57, 85
Tally Brightness	57, 85
Tally lamp	17, 107
Tilt	104
Tilt head	17
Time adjustment	91
Time adjustment interval	92
Time & date	71, 101
Date/time	71
End time & date	71
NTP	71
Start time & date	71
Summer time (daylight saving)	71
Time zone	71
Time zone	92
Top Menu	46
Transmission priority	74
Transmission type	75
Tripod screw holes	18

U

Unicast port1 (Image)	75
Unicast port2 (Audio)	75
Updating	101
Upload	103
UPnP	92, 102
User auth.	87
User check	87
User mng.	87
User name	87

V

VAR	33
V Detail Level	49, 79
Video Out	57, 85
VIDEO OUT connector	18
Video over IP	72
Viewer software installation counter	101

W

Web screen	63
Web setup screen	64, 70
White balance	32
White Balance Mode	49, 79
White Clip	50, 80
White Clip Level	50, 80
Wireless Control	57
Wireless remote control	16, 20, 22
Wireless remote control signal light-sensing area	17

Z

Zoom	67, 82, 104
------------	-------------



Disposal of Old Equipment

Only for European Union and countries with recycling systems

This symbol on the products, packaging, and/or accompanying documents means that used electrical and electronic products must not be mixed with general household waste.

For proper treatment, recovery and recycling of old products, please take them to applicable collection points in accordance with your national legislation.

By disposing of them correctly, you will help to save valuable resources and prevent any potential negative effects on human health and the environment. For more information about collection and recycling, please contact your local authority, dealer or supplier.

Penalties may be applicable for incorrect disposal of this waste, in accordance with national legislation.